

工业缝纫机数控交流伺服系统

Industrial Sewing Machine Digital AC Servo System

# 用户手册

# User Manual

# 目 录

前言 .....	1
安全说明.....	1
<b>1 产品介绍.....</b>	<b>2</b>
1.1 概述 .....	2
1.2 组成 .....	2
1.3 基本参数.....	2
<b>2 安装图.....</b>	<b>3</b>
2.1 下挂电机的安装.....	3
2.2 直驱控制器的安装.....	3
2.3 控制器外形尺寸 .....	3
2.4 接线与接地 .....	4
2.5 控制器接口定义.....	4
<b>3 操作面板概述 .....</b>	<b>5</b>
3.1 面板显示说明 .....	5
3.2 操作面板按键说明.....	6
<b>4 用户模式定义.....</b>	<b>6</b>
4.1 操作员模式 .....	6
4.1.1 缝纫模式功能置 .....	7
4.1.2 前/后加固缝功能设置 .....	7
4.1.3 软（慢速）启动功能设置 .....	7
4.1.4 抬压脚功能设置 .....	7
4.1.5 剪线功能设置.....	7
4.1.6 触发功能设置.....	8
4.1.7 停针位控制功能设置.....	8
4.1.8 机头灯亮灭选择键 .....	8
4.1.9 补针功能设置.....	8
4.2 技术员操作模式.....	8
4.3 系统员操作模式.....	11
4.4 监控模式.....	13
4.5 错误报警模式.....	13
4.6 安全开关报警模式.....	13
<b>5 控制系统安装后操作： .....</b>	<b>14</b>
<b>6 控制系统恢复出厂参数设置： .....</b>	<b>14</b>
6.1 恢复电控厂家出厂参数 .....	14
6.2 恢复用户自定义出厂参数.....	14
<b>7 故障处理及维护 .....</b>	<b>15</b>

## 前言

 注意	使用前请仔细阅读本用户手册及所搭配的缝制设备说明书，配合正确使用，并须由接受过专业培训的人员来安装或操作。
-----------------------------------------------------------------------------------------	-------------------------------------------------------

本产品仅适用于指定范围的缝制设备，请勿移做其他用途。

本公司拥有对此用户手册的最终解释权。

使用中若存有有任何疑问或对我们的产品及服务有任何意见或建议，请随时与我们联系。

## 安全说明

- 1) 安装和调试前，请仔细认真地阅读本手册。
- 2) 本手册中标有<sup>!</sup>符号之处为安全注意点，必须特别注意并严格遵守，以免造成不必要的损害。
- 3) 本产品须由受过专业培训的人员来安装或操作。
- 4) 确保电源安全接地并符合产品铭牌上标示的电压范围及技术要求。
- 5) 接通电源开关时，请把脚离开脚踏板。
- 6) <sup>!</sup>在进行以下操作时，必须先断开系统电源：
  - 安装机器时；
  - 在控制箱上插拔任何连接插头时；
  - 穿针线，换机针及翻抬机头时；
  - 机器休息不用及修理或调整时。
- 7) 拧紧所有紧固件，以防止缝制作业时产生振动或停针位置错位等异常现象。
- 8) 每次关闭控制系统后再次启动，应相隔 30 秒以上。
- 9) 设置系统控制参数或进行保养修理工作应由受过相关培训的专业人员来完成。
- 10) 维修所用的所有零部件，必须由本公司提供或认可，方能使用。
- 11) 接地线的安装（特别注意）。

 注意	安装控制器时必须正确接地，否则将导致控制器无法正常工作，更严重的可能会被电击（详见安装章节）。
-------------------------------------------------------------------------------------------	-------------------------------------------------

# 1 产品介绍

## 1.1 概述

此系列工业缝纫机数控交流伺服系统，电机与控制器分体吊装，使配置组合灵活方便，电机与控制器可按需搭配，实现多种缝纫机对功率、速度等的配套要求；安装简易、调整便捷、力矩大、体积小、噪音低、效率高（省电！）；采用开关电源供电，使其具有更宽的电压适配范围；电磁铁侧面接插，使连接更可靠，避免油渍污染引起的控制器故障；优化交流伺服电机控制策略，使转速控制精度高，停针速度快；专利设计的吊装方式使安装更简捷，整体震动降至最低，系统运行更平稳；具有电磁铁回路短路保护功能，防止错误接线损坏控制器。

## 1.2 组成

系统分为主件和附件两部分。系统主件如图 1-1 所示：



图 1-1 控制箱

控制器配的操作面板，如图 1-2 所示

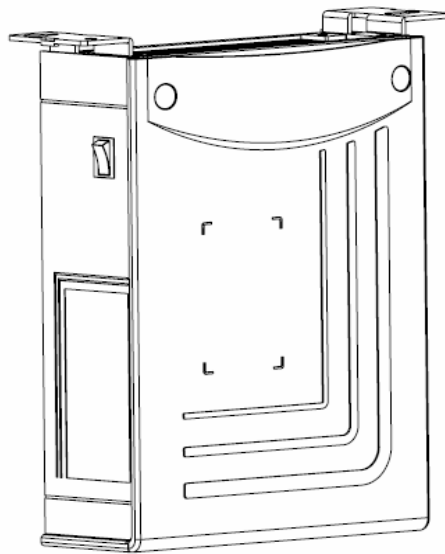

图 1-2 操作面板

注：请仔细检查包装箱中是否包含装箱单所列的全部元件，如不全，请尽快向供货方说明并补全。

## 1.3 基本参数

此系列数控交流伺服系统的基本参数详见表 1。

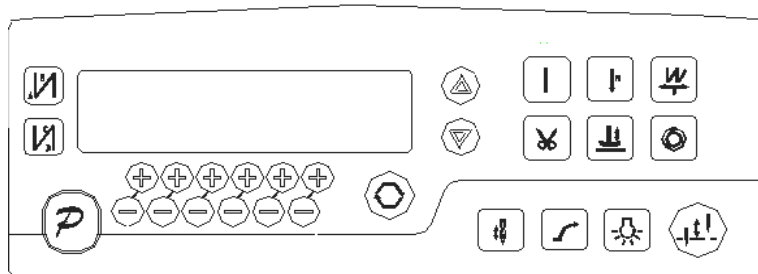
控制器型号	P6AC50-2AF-001	P7AC50-2AF-001
电机最大转速 (r/min)	5000	
电源电压	AC 220 ± 20% V 50/60HZ	
输出功率	500W	
电机低速最大转矩	3Nm	
工作环境	0℃ — 40℃	
电机传动方式	皮带	直驱

## 2 安装图

### 2.1 下挂电机的安装

第一步：安装吊装螺栓，若缝纫机台板上无预留定位孔时则需按图 2-1 所示尺寸钻孔，置入定位吊装螺栓。



图 2-1 螺栓钻孔尺寸图

第二步：安装电机（见图 2-2）。将电机吊上吊装螺栓后紧固。

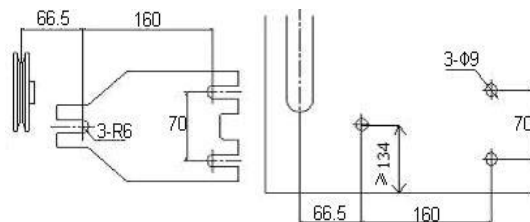

图 2-2 电机安装示意图

### 2.2 直驱控制器的安装

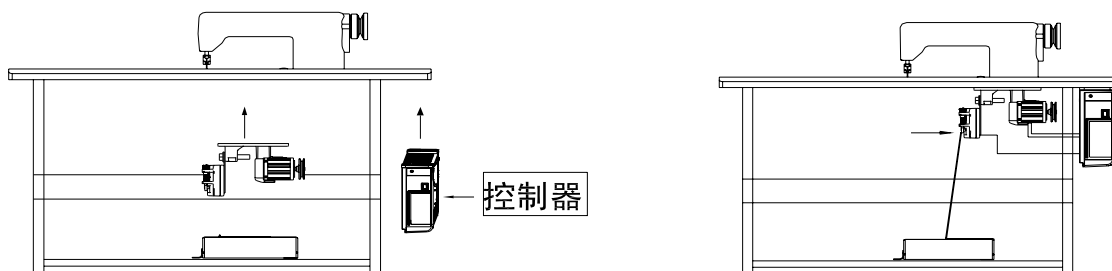

图 2-3 控制器安装示意图

### 2.3 控制器外形尺寸

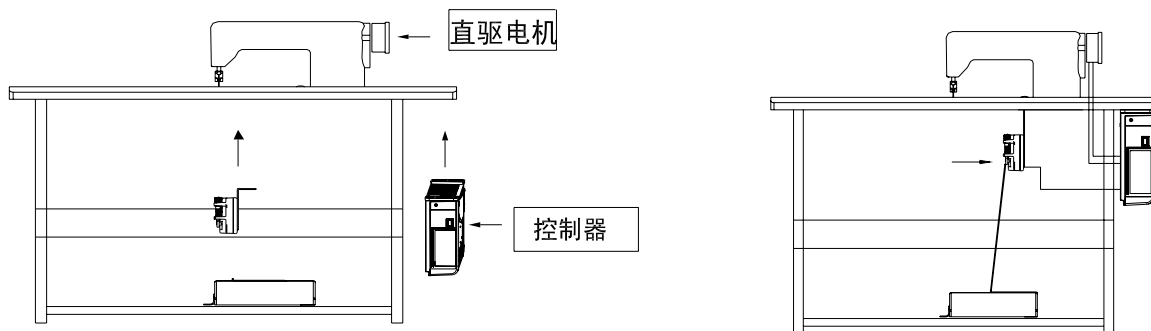

图 2-4 控制器尺寸图

## 2.4 接线与接地

系统上电及投入使用前，必须确保 AC 输入端已安全可靠的接地（如图 3-1 所示）。系统的接地线为黄绿线，该地线请务必可靠连接至机头上（如连接到机头的螺丝上），以保证安全使用，并可防止出现异常情况。

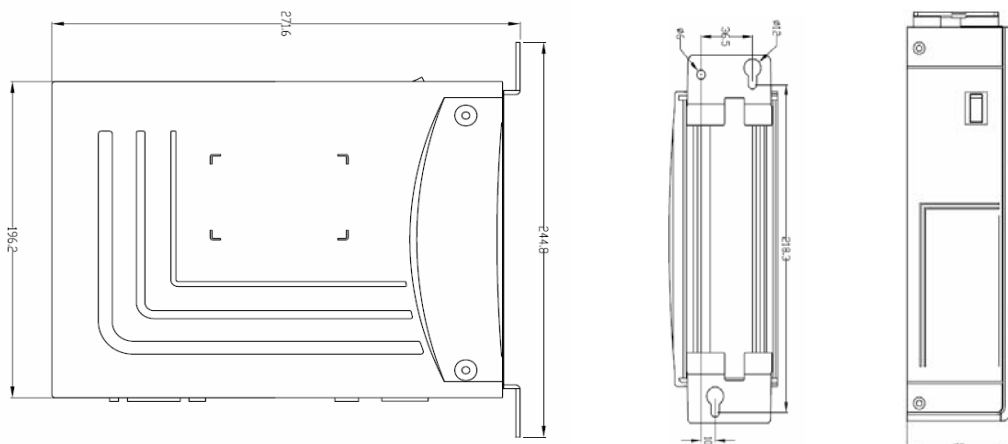

图 3-1

 注意	<p>所有电源线、信号线、接地线等接线时不要被其它物体压到或过度扭曲，以确保使用安全！</p>
--------	-------------------------------------------------

当电源系统配置为三相四线式 / 三相五线式 380V 时，欲使用单相 220V 供应本电机的接线方式如图 3-2 所示：

 注意	<p>如果此配置系统没有 [中性 (点) 线] 时，本伺服电机不适合在此场所使用。</p>
--------	-----------------------------------------------

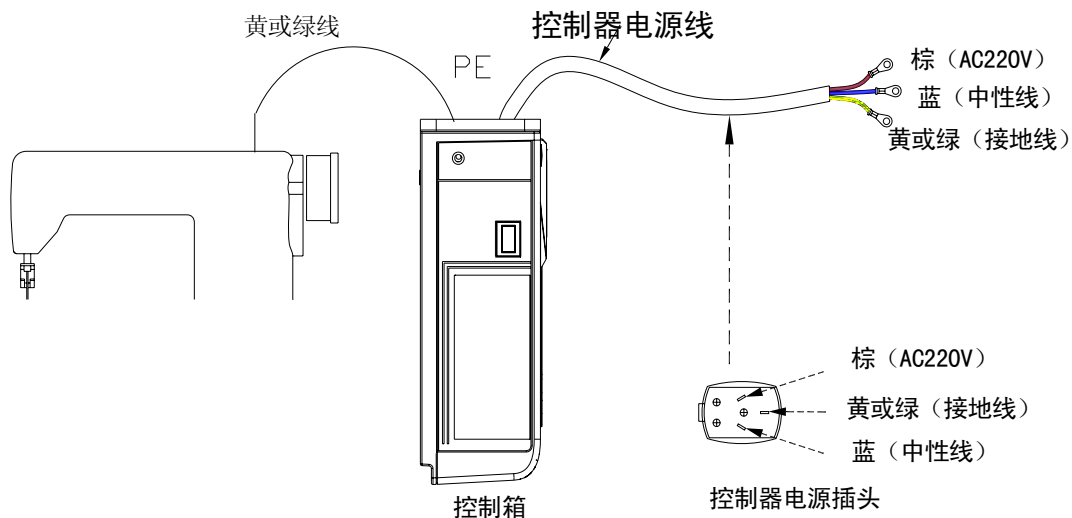

图 3-2

## 2.5 控制器接口定义

控制箱与电机同步传感器组件、操作面板和电源线等的连接如图 4-1 所示，将各个连线的插头插入控制箱上对应的插座即可。装好后，检查一下插头是否插牢。

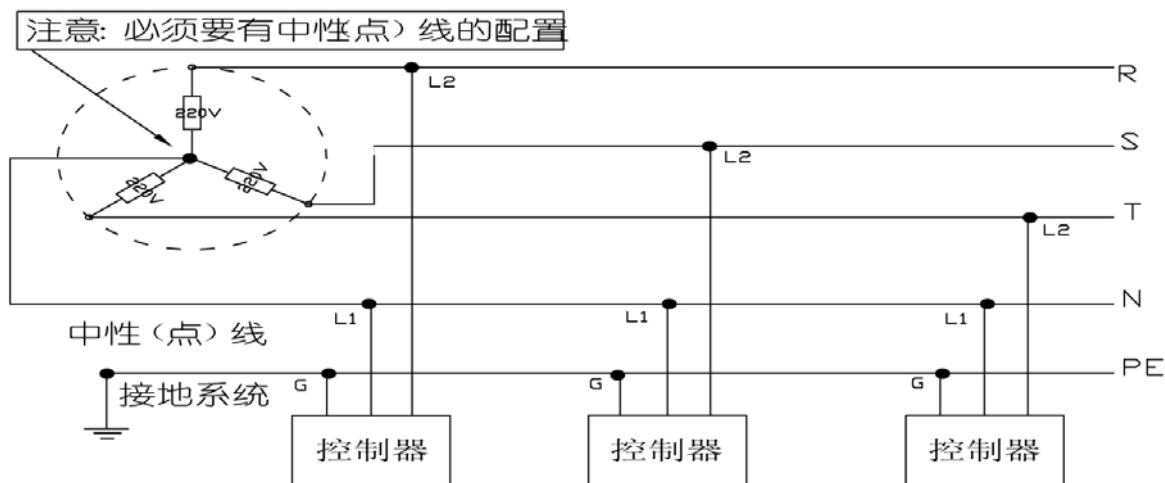

图 4-1 控制器对外接口示意图

**\*注：机头 LED 灯接口的驱动能力：**

额定电流为 100mA，额定电压为 5V。

推荐的 LED 发光二极管参数：

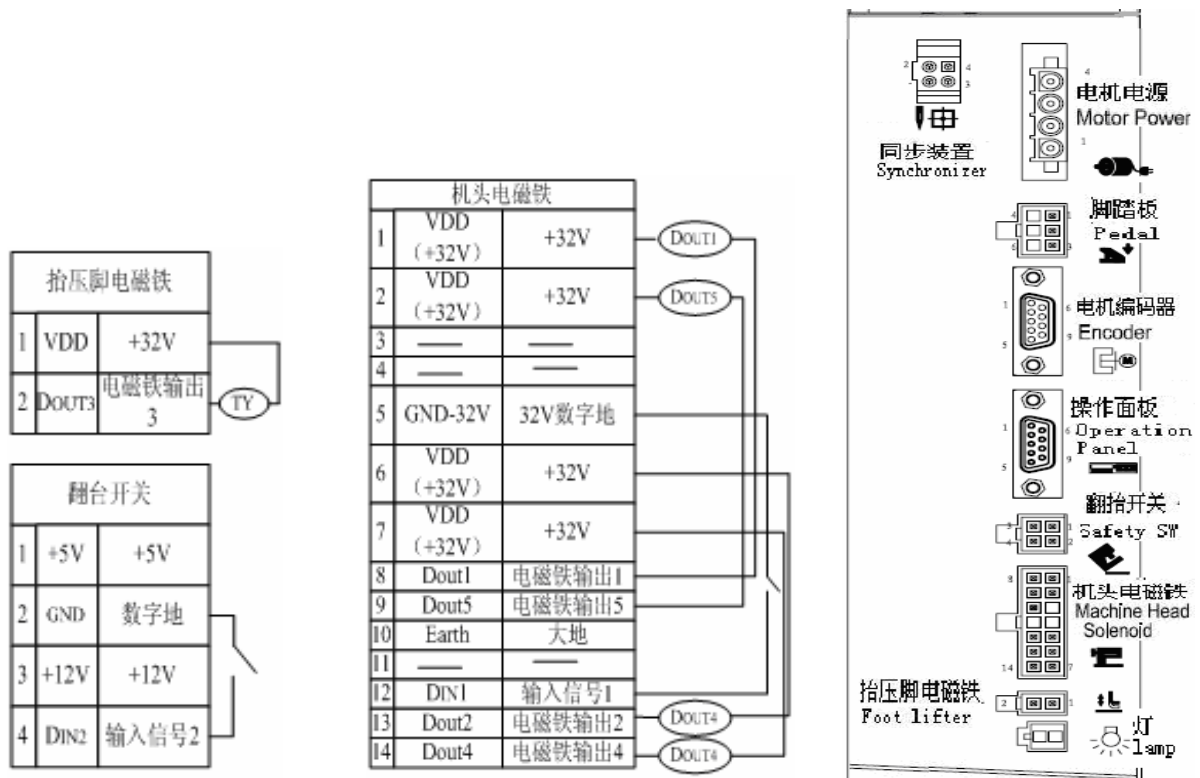
VF: Min. = 3.0V, Max. = 3.6V (test condition IF = 20mA);

Peak Forward Current: Max. = 80mA;

Continuous Forward Current : Max. = 35mA



**注意：** 使用正常的力量插不进去时，请检查插头与插座是否匹配，插入方向或针的方向是否正确。

### 3 操作面板概述

#### 3.1 面板显示说明

操作面板（如图 3-1 所示），正面分为两大区域：液晶显示区域及按键操作区。



图 3-1

在整个操作面板正面的左边偏上位置，为液晶显示区域，用于显示当前系统状态，包括缝纫模式、各种参数、前/后固缝设置，以及抬压脚、停针位、剪线、慢速起缝等液晶字符。系统上电后操作面板将自动进行一次自检，这时液晶显示区内的所有图标会闪亮一次，而后只显示系统的当前设置，其他没有选择的功能其所代表的图标将不被点亮。如图 1-2 所示，图中是所有液晶字段均被点亮的状态。



图 1-2

### 3.2 操作面板按键说明

操作面板每个按键的说明详见表 1。

表 1：操作面板按键说明

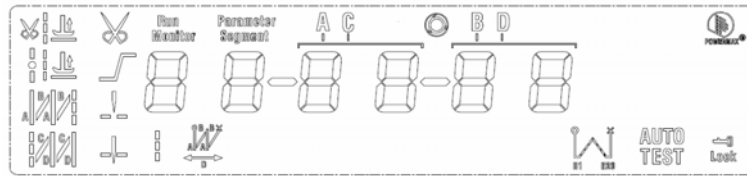
序号	外观	描述
1		功能键：主要起确定操作和确认参数设置的作用，还可以与其它按键组合进入更高级的参数设置；
2		前加固缝（起始倒针）功能选择键：每有效按动一次，设置将在前单固缝、前双固缝、前四固缝和无前固缝之间循环选择，选择时液晶屏幕左边会显示出设置的前固缝液晶字符标识；详见“2.1.2 前/后加固缝设置”说明。
3		后加固缝（结束倒针）功能选择键：每有效按动一次，设置将在后单固缝、后双固缝、后四固缝和无后固缝之间循环选择，选择时液晶屏幕左边会显示出设置的后固缝液晶字符标识；详见“2.1.2 前/后加固缝设置”说明。
4		自由缝纫模式键：每有效按动一次系统即进入自由缝工作模式状态，功能选择后液晶屏幕下方会显示自由缝状态标识，详见“2.1.1 缝纫模式设置”说明。
5		多段缝模式选择键：每有效按动一次，液晶显示出多段缝的段数设置参数，按 P 键后进入各段数的针数设置，功能选择后液晶屏幕下方会显示多段缝状态标识，详见“2.1.1 缝纫模式设置”说明中多段缝的设置说明。
6		W 缝键：每有效按动一次，系统即进入 W 缝工作模式状态，功能选择后液晶屏幕下方会显示 W 缝状态标识，详见“2.1.1 缝纫模式设置”说明中 W 缝的设置说明。
7		软启动键：用于选择进入软启动状态，选择软启动功能后液晶屏幕上方会显示软启动状态。
8		抬压脚键：每有效按动一次，设置将在剪线后抬压脚、缝纫终止抬压脚和无自动抬压脚之间循环选择，选择后液晶屏幕上方会显示出当前的状态；详见“2.1.4 抬压脚设置”。
9		剪线键：用于选择或取消自动剪线功能。选择后液晶屏幕上方会显示剪线状态标识，详见“2.1.5 剪线设置”。
10		触发键：用于选择或取消触发方式，该按键只在多段缝工作模式下有效，当选择触发模式后，点动脚踏板一次即可完成多段缝中的某一段针数缝制；选择后液晶屏幕上方会显示触发方式标识，详见“2.1.6 触发设置”。
11		停针位键：用于选择缝纫暂停时系统的上/下停针，选择后液晶屏幕上方会显示上停针或下停针的状态标识，详见“2.1.7 停针位设置”。【注：自动剪线后，系统始终在上针位】
12		机头灯键：用于选择点亮或熄灭机头照明灯，选择点亮照明灯后通过操作面板供电的 5V 机头 LED 灯会亮起。
13		补针键：有效按下时启动补针功能，松开按键时关闭补针功能。
14		临时增速键：按下后可调节临时增加缝纫转速。
15		临时减速键：按下后可调节临时减小缝纫转速。
16		参数和索引值增加键：按下增加对应位的索引或参数值。
17		参数和索引值减小键：按下减小对应位的索引或参数值。

## 4 用户模式定义

### 4.1 操作员模式











在操作员模式中，可以在已设定好技术参数的情况下选择使用各种缝纫模式。作为预设的缺省设置，系统开机初始化后即进入此模式，在此模式下可进行正常的缝制工作及模式切换等基本功能的实现，而不能修改任何内部参数及设置。





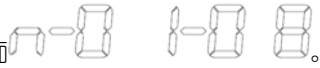





**注：在执行任何操作的时候，如果长时间不按键，操作面板会自动切换到空闲状态，前面执行的操作将不会被执行！**



#### 4.1.1 缝纫模式功能设置

**自由缝模式：**按下  键，在液晶显示区自由缝模式图标  会亮，液晶显示 ，表示已经选择了自由缝模式，踩下踏板即可开始缝纫。

**多段缝模式：**按下  键，在液晶显示区定长缝模式图标  会亮，液晶显示  为多段缝操作界面。可以使用最后两位  和  键来确定所需要的多段缝模式段数（最高 24 段），然后按  键，进入多段缝每段针数设置界面 。在多段缝每段针数设置界面里面，可以用第三位和第四位  和  键来选择所需要修改的段数，用第五位和第六位  和  键来修改针数。

**W 缝模式：**按下  键，在液晶显示区定长缝模式图标  会亮，液晶显示  为 W 缝界面。以使用第三位和第四位  和  键选择 A 段的针数，设置范围：1-99 针；使用第五位和第六位  和  键选择 B 段的针数，设置范围：1-99 针。可用  键可切换到 D 段设定画面为 ，使用第五位和第六位  和  键选择 D 段的针数，设置范围：1-99 针。



#### 4.1.2 前/后加固缝功能设置

第一步：按下  键修改前加固缝设置。

前加固缝有如下四种模式：

- ◆  无前固缝
- ◆  前单固缝
- ◆  前双固缝
- ◆  前四固缝

第二步：使用上述的按键在上述的四个模式中循环选择需要的前固缝模式，停止按键进行确认，即可选中该前加固缝模式。





第三步：然后使用  和  键修改对应的参数值（A、B 的值），设置范围：1-99 针。设置好针数即完成了前加固缝设置。

备注：除按键不同外，后加固缝的设置方法与前加固缝设置方法基本相同。



#### 4.1.3 软（慢速）启动功能设置

按  键后，选择软启动功能，选择后液晶屏幕上显示 ，再按一下可以退出软启动状态，液晶屏幕上熄灭 。



#### 4.1.4 抬压脚功能设置

按  键即可进入抬压脚设置，抬压脚有四种设置：不自动抬压脚、剪线后自动抬压脚 ()、缝纫中停车自动抬压脚 ()、剪线后和停车时都自动抬压脚，每按动  键一次，设置将在上面四种抬压脚设置间循环切换，停止按键抬压脚设置即告完成。





#### 4.1.5 剪线功能设置

按动  键即可进入剪线设置，可以设置为不剪线和剪线两种方式。反复按下  键，液晶显示区  图标被点亮或消隐。设置为剪线模式时该图标点亮，设置为不剪线模式时该图标消隐。点亮则表示已经选择剪线功能，消隐则表示不选择剪线功能。

#### 4.1.6 触发功能设置

使用  键：选择/不选择触发方式。选择触发方式后，液晶显示屏显示 ，在多段缝模式下，点动脚踏板一次，系统自动完成当前段的设定针数。再按一下可以退出触发方式，液晶显示屏  熄灭。

#### 4.1.7 停针位控制功能设置

按动  键可对停针位进行设定，可以设置为中间缝纫停止时系统停在上针位或者下针位。反复按下  键，在 （下停针）和 （上停针）之间切换。选择所需的停针位，停止按键进行设置确认。

#### 4.1.8 机头灯亮灭选择键



使用  键：选择点亮或熄灭由操作面板 5V 供电的机头照明灯。



#### 4.1.9 补针功能设置

使用  键：当按下时候启动补针功能。补半针、补一针取决于按下的时间；如果保持按下，则系统运行连续补针，直至松开补针按键。

### 4.2 技术员操作模式

在技术员操作模式中，可以根据使用需要，调整或重设各功能模式的相应技术参数，使系统工作在最好的工况下，进入参数设定的方法如下：

第一步：在操作员模式下，先按下  键不放，再  按键，液晶会显示 PD - 0000，要求键入系统设置的密码。

第二步：使用后四个  键和  键输入密码，然后按下  键。如果密码正确，即进入技术员模式，否则退回到操作员模式。

第三步：技术员模式下，使用第一个和第二个  键和  键来改变技术员参数索引。技术员参数详见表 2。

第四步：使用后四个  键和  键更改参数值。

第五步：在技术员模式下，按下  键，操作面板退回到操作员模式。

2: 技术员模式参数表

参数分类	参数号高位	参数号低位	默认值	参数范围	注释
速度参数	0	0	200	100 ~ 800	起始缝纫速度
		1	4000	200 ~ 5000	自由缝最高速度（全局最高限值）
		2	3000	200 ~ 5000	定长缝最高速度
		3	4000	200 ~ 5000	手动倒缝最高限值
		4	200	100 ~ 800	补针速度
		5	250	100 ~ 500	剪线速度
		6	0	0 / 1	慢速启动模式：0：仅剪线后有慢速启动，1：剪线后、中间停止都有慢速启动
		7	2	1 ~ 9	慢速起缝针数
		8	200	100 ~ 800	慢速起缝速度
		9	20	1 ~ 20	系统加速灵敏度（对于直驱传动可设置为较大的值；对于皮带传动不要设置太大，否则振动、噪声较大。此参数不影响电机出力）
		A	20	1 ~ 20	系统减速灵敏度（对于直驱机头可设置为较大的值；对于皮带传动不要

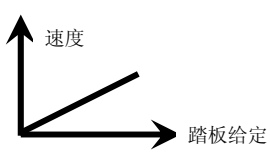
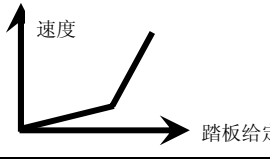
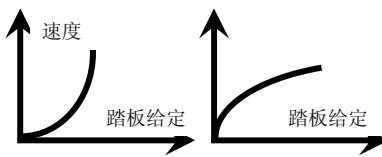
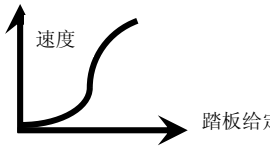
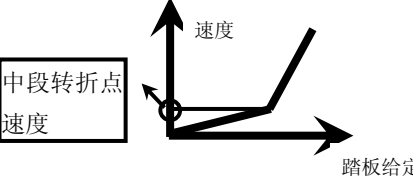
参数分类	参数号高位	参数号低位	默认值	参数范围	注释
					设置太大，否则振动、噪声较大。此参数不影响电机出力)
加固缝参数	1	0	1800	200 ~ 2200	前加固缝速度
		1	1800	200 ~ 2200	后加固缝速度
		2	1800	200 ~ 2200	连续回缝 (W 缝) 速度
		3	24	0 ~ 70	前加固缝针迹补偿 1
		4	20	0 ~ 70	前加固缝针迹补偿 2
		5	24	0 ~ 70	后加固缝针迹补偿 1
		6	20	0 ~ 70	后加固缝针迹补偿 2
踏板参数	3	0	0	0 / 1 / 2 / 3	脚踏板控速曲线模式： 0: 自动线性斜率 (根据最高速自动计算) 
踏板参数	3	0	0	0 / 1 / 2 / 3	1: 两段斜率 (可自由设定为先缓后快或先快后缓, 需配合参数【31】和【32】使用) 
					2: 幂次曲线 (需配合参数【33】使用) 
					3: S 型曲线 (先缓后快, 低速操控性好) 
踏板参数	3	1	3000	200 ~ 4000	两段控速斜率辅助参数: 中段转折点速度 RPM (两段斜率的转折点速度), 在参数【30】设置为 1 时有效。 
		2	800	0 ~ 1024	两段控速斜率辅助参数: 中段转折点踏板模拟量值, 当参数【30】设置为 1 时有效, 参数设定值需在参数【38】到【39】的值之间。

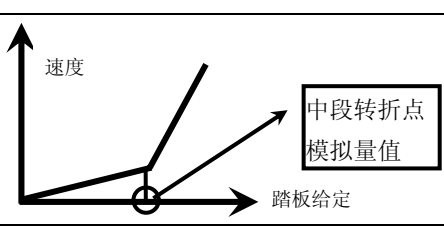
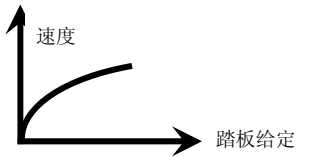
参数分类	参数号高位	参数号低位	默认值	参数范围	注释
踏板参数	3				 <p>速度</p> <p>踏板给定</p> <p>中段转折点 模拟量值</p>
		3	2	1 / 2	幂次控速曲线辅助参数： 在参数【30】设置为2时有效。 1: 平方（先缓后快，低速操控性好）；  <p>速度</p> <p>踏板给定</p> 2: 开方（先快后缓，响应速度快）；  <p>速度</p> <p>踏板给定</p>
		4	90	0 ~1024	踏板剪线位置设定，如图 2-1 所示。 (设定值不得高于参数【35】)
		5	300	0 ~1024	踏板抬压脚位置，如图 2-1 所示。 (设定值介于参数【34】和【36】之间)
		6	419	0 ~1024	踏板回中位置，如图 2-1 所示。 (设定值介于参数【35】和【37】之间)
		7	510	0 ~1024	踏板前踩运行位置，如图 2-1 所示。 (设定值介于参数【36】和【38】之间)
		8	578	0 ~1024	踏板低速运行位置（上限），如图 2-1 所示。 (设定值介于参数【37】和【39】之间)
		9	962	0 ~1024	踏板模拟量最大值，如图 2-1 所示。 (设定值不得低于参数【38】)
		A	100	0 ~800	踏板抬压脚确认时间
		习惯设定	4	0	1
1	1			0 / 1	自动加固功能选择： (无自动加固功能的机头，最好禁止) 0: 禁止固缝；1: 允许固缝。
2	0			0 / 1	手按回缝时功能模式选择 0: Juki 模式。在缝纫中途或中途停止时均有动作。 1: Brother 模式。仅在缝纫中途有动作。
3	0			0 / 1 / 2 / 3	特殊运行模式： 0: 操作工选择 1: 简易缝模式 2: 测电机初始角（不需要取下皮带） 3: 计算传动比模式（需要有停针传感器，且不能取下皮带）

参数分类	参数号高位	参数号低位	默认值	参数范围	注释
		4	0	0-31	电机低速加力功能开关： 0: 正常功能 1-31: 低速加力过厚能力档位
		5	1	0/1	停针模式： 0: 匀速滑车模式（皮带传动方式下，停车精度不高） 1: 回拉模式（PMX 模式）
		6	100	0~800	按钮补半针命令时间
		7	150	0~800	按钮补一针命令时间
操作类	6	1	0	0/1/2	参数传输方式： 0: 无动作； 1: 下传参数（自操作面板向控制器传参数）； 2: 上传参数（自控制器向操作面板传参数）。
		2	0	1, 2, XXXX	恢复出厂参数（仅恢复操作员、机修、厂商等参数） 皮带平车默认恢复出厂参数 1000 直驱平车默认恢复出厂参数 2000
		3	0	1, 2	保存当前参数为 User 自定义机修参数（可恢复）
		注：以上【6X】操作类参数不保存。			



图 4-1 踏板动作参数各位置示意图

### 4.3 系统员操作模式

在系统员操作模式中，可以根据需要使用，调整各种电磁铁的控制参数设置，使得伺服系统能正常运转，参数设定如下：

**第一步：**在操作员模式下，先按下 **P** 键不放，再按 **Enter** 键，液晶会显示 PD - 0000，要求键入系统员设置的密码。

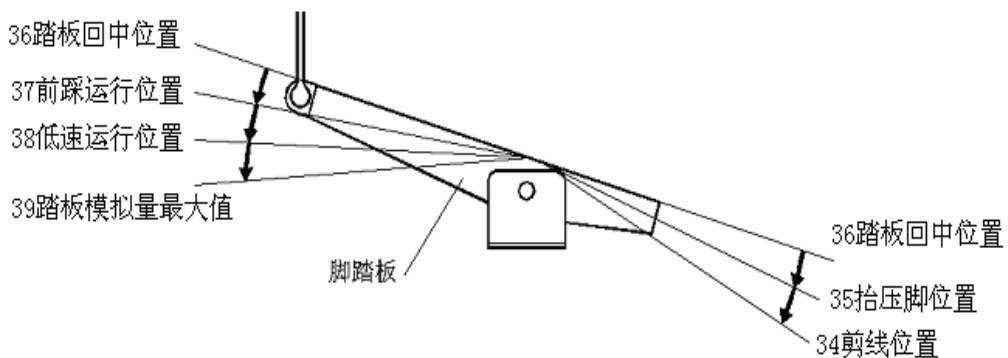
**第二步：**使用后四个 **+** 键和 **-** 键输入密码，然后按下 **P** 键。如果密码正确，即进入系统员模式，否则退回到操作员模式。

**第三步：**使用第一个和第二个 **+** 键和 **-** 键来改变系统员参数索引，系统员参数详见表 3。

**第四步：**使用后四个 **+** 键和 **-** 键更改参数值。





**第五步：**在系统员模式中，按下 **P** 键，操作面板即退回到操作员模式。

表 3: 系统员模式参数表

	参数号 高位	参数号 低位	默认值	参数范围	注释
剪线 模式	0	2	1	0 / 1 / 2 / 3	剪线时序选择: 0: 按系统员参数【03】设定的角度进行剪线, 直至上停针后延时系统员参数【06】设定的时间为止。 1: 按系统员参数【03】设定的角度进行剪线, 直至系统员参数【04】设定角度为止。 2: 按系统员参数【03】设定的角度进行剪线, 延时系统员参数【06】设定的为止。 3: 下针位信号后延迟系统员参数【05】设定的时间进行剪线, 延时系统员参数【06】设定的时间为止。
		3	10	5 -359	剪线开始角度 (相对于下针位角度)
		4	120	10 -359	剪线结束角度 (相对于下针位角度, 需大于系统员参数【03】)
		5	10	1 -999	剪线开始延时 T1 (ms)
		6	60	1 -999	剪线结束延时 T2 (ms)
松线 扫线 夹线 模式	1	0	0	0 / 1 / 2 / 3 / 4	松线电磁铁时序选择: 0: 按系统员参数【11】设定的角度后进行松线动作, 直至上针位再延迟系统员参数【14】所设定的时间为止。 1: 按系统员参数【11】设定的角度后进行松线动作, 直至系统员参数【12】设定的角度为止。 2: 按系统员参数【11】设定的角度后进行松线动作, 延迟系统员参数【14】所设定的时间为止。 3: 下针位信号后延迟系统员参数【13】设定的时间进行松线动作, 延迟系统员参数【14】所设定的时间为止。 4: 上针位信号后延迟系统员参数【13】设定的时间进行松线动作, 延迟系统员参数【14】所设定的时间为止。
		1	25	5 -359	松线电磁铁启动角度 (相对于下针位角度)
		2	350	10 -359	松线电磁铁结束角度 (相对于下针位角度, 需大于系统员参数【11】)
		3	1	1 - 999	松线电磁铁启动延迟时间 T1 (ms)
		4	10	1 - 999	松线电磁铁上针位后延迟时间 T2 (ms)
		5	1	0 / 1	扫线功能选择: 0: 关闭, 1: 打开。
		6	10	1 - 999	拨线 / 扫线延迟时间 ms
		7	70	1 - 9999	拨线 / 扫线持续时间 ms
		8	50	1 - 999	拨线 / 扫线复原时间 ms
		9	0	0 / 1	钳线功能选择: 0: 关闭, 1: 打开。
		10	70	0 - 359	钳线开始角度
11	140	0 - 359	钳线结束角度		
停止 模式	3	1	0	0 / 1	自动测试模式选择: 0: 定针数, 1: 定时间。

	参数号 高位	参数号 低位	默认值	参数范围	注释
		2	300	0 ~ 1000	安全开关报警确认时间 ms (不区分直驱翻台开关和绷缝剪刀保护开关, 统一处理方式)
		3	50	0 ~ 1000	安全开关恢复确认时间 ms
		4	0	0 / 1	电机转向: 1: 反转, 0: 正转。
机头 相关 参数	4	0	1000	0 - 9999	电机/机头传动比: 单位 0.001 (如果自动计算过传动比, 控制器内的该参数可能与操作面板上的参数不同)
		2	0	0 - 359	上停针位调整角度 (相对于上针位传感器的位置偏移)
		3	155	0 - 359	下针位机械角度
		4	200	0 - 800	放压脚延迟时间 (ms)

#### 4.4 监控模式

在操作面板空闲状态时, 先按住  键, 再按  键, 即可进入监控模式。用第一个和第二个  键和  键可以切换需要观看的监控参数。

监控参数的具体内容如下表的表 4 所示, 如果在规定时间内没有按键操作, 操作面板会自动返回到空闲状态。

表 4: 监控模式参数表

	参数号 高位	参数号 低位	参数单位	注释
监控 状态	1	0	次	针数计数
		1	次	剪线计数
	2	0	V	母线电压
		1	RPM	机头速度
		2	0.01A	相电流
		3	degree	初始角度
		4	degree	机械角度
		5	---	踏板电压采样值
		6	0.001	传动比
		7	小时	电机累计运行时间
	8	---	机头交互速度信号采样值	
3	0 - 7	---	8 个历史故障代码	

#### 4.5 错误报警模式

当系统检测出错误时候, 操作面板会自动跳转到错误报警模式, 液晶显示 。在错误报警模式内, 操作面板仍可以跳转去做技术员参数、系统员参数和其他操作面板参数的修改, 并且监控模式仍有效, 退出这些模式后, 操作不返回空闲状态, 还是跳转回错误报警模式, 系统在修正错误后, 需要断电再上电才可以正常运行工作, 常用的错误代码及处置方法可参考控制器用户手册。

#### 4.6 安全开关报警模式

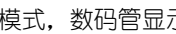
当伺服控制系统检测到安全开关 (常用于例如机头翻抬开关等) 动作时, 操作面板会自动跳转到安全开关报警模式, 数码管显示 。在安全开关报警模式内, 仍可以跳转去进行技术员参数、系统员参数和操作面板自身参数的修改, 以及进入监控模式。退出这些模式后不返回空闲状态, 还是返回安全开关报警模式。

(P 系列统一处理安全开关输入，不区分翻台开关、剪刀保护开关)

## 5 控制系统安装后操作：

1、控制系统安装后，使用前应当做一次“自动计算传动比”操作（由于加工精度的原因，不同厂家的机头手轮有效半径各不相同，即使是直驱系统也不一定是 1:1 的传动比）。进入技术员【43】参数，设置该参数值为 3。轻点踏板启动，系统以中速旋转大约 10 圈后停止，计算出的结果直接保存在机内。然后将【43】参数恢复为 0。

如果能确认传动比的值，可以直接设定系统员【40】参数。控制器内保存的实际传动比可以通过监控参数【26】得到。



2、P 系列版本及以上控制系统的下停针，不再依靠下停针信号确定。而是由系统员【43】参数确定，该参数确定下针位相对于上针位的机械角度。当前的机械角度可以通过监控【24】参数显示给用户，上针位的机械角度为 0。



（上电后，控制系统需要至少一次运行经过上针位校正机械角度，如：找上针位。传动比的值会影响机械角度的计算，建议先确定正确的传动比后，再调整下针位位置）。





3、P 系列版本及以上控制系统带有 5 个电磁铁驱动输出，并采用了全新的软件设计。其中第 2、3 号输出有斩波调节电流能力（默认为倒缝、抬压脚电磁铁的驱动），其它输出不能斩波。使用前请确认系统员【6x】参数中设定的各个驱动输出的功能设定与电磁铁接口的连接是否一致；还需确认系统员【7x】、【8x】参数，否则可能出现电磁铁出力不足。（默认参数按照大多数厂家的电磁铁连接定义设定）



## 6 控制系统恢复出厂参数设置：

### 6.1 恢复电控厂家出厂参数

第一步：在操作员模式下，先按下  键不放，再按  键，液晶会显示 PD - 0000，要求键入系统员设置的密码。



第二步：使用后四个  键和  键输入密码，然后按下  键。如果密码正确，即进入系统员模式，否则退回到操作员模式。



第三步：使用第一个和第二个  键和  键来改变系统员参数索引至【62】，使用后四个  键和  键更改成电控厂家提供的出厂参数恢复值，一般为四位。





第四步：确认参数输入无误后，按住  键不动，直至操作面板红灯常亮或翁鸣器长响一声之后，松开  键，操作面板和整个系统即恢复到出厂设置状态。

### 6.2 恢复用户自定义出厂参数

使用操作面板参数【63】可将当前用户设置的个性化参数作为自定义参数，操作方法如下：

第一步：在操作员模式下，先按下  键不放，再按  键，液晶会显示 PD - 0000，要求键入系统员设置的密码。

第二步：使用后四个  键和  键输入密码，然后按下  键。如果密码正确，即进入系统员模式，否则退回到操作员模式。

第三步：使用第一个和第二个  键和  键来改变系统员参数索引至【63】，使用最后一组  键和  键将数值改为 1 或 2。

注：设置为 1 则后续恢复用户自定义出厂参数的时候使用的就是 1，设置为 2 则后续恢复用户自定义出厂参数的时候使用的就是 2。



第四步:按住  键 5 秒钟左右以后,操作面板和整个系统即可将当前参数设置定义为用户自定义恢复出厂参数。

当系统因参数设置导致控制系统出错时,用户可以使用自定义的恢复出厂参数调整过来,操作方法同“6.1 恢

复电控厂家出厂参数”说明一样,将系统员参数【62】更改为 1 或 2,长按  键 5 秒钟以后,系统会恢复至用户自定义的参数设置。

注意事项:

- 1、上电后操作面板仅下传操作员模式的参数,不会主动下传技术员与系统员的参数。如果确定要下传一次全套参数,可以通过技术员参数【61】主动下传操作面板中的全部当前活动参数。
- 2、如果要恢复操作面板中保存的其他参数,需通过技术员参数【62】激活为当前活动参数,并主动下传。
- 3、单个参数修改完后,操作面板确认该参数修改后的值与修改前不同时,才下传该参数。
- 4、恢复出厂参数之后,系统最好重新上电复位一次。

## 7 故障处理及维护

故障代码	代码含义	解决措施
01	硬件过流	关闭系统电源, 30 秒后重新接通电源, 控制器若仍不能正常工作, 请更换控制器并通知厂方。
02	软件过流	
03	系统欠压	断开控制器电源, 检查输入电源电压是否偏低 (低于 176V)。若电源电压偏低, 请在电压恢复正常后重新启动控制器。若电压恢复正常后, 启动控制器仍不能正常工作, 请更换控制器并通知厂方。
04	停机时过压	断开控制器电源, 检查输入电源电压是否偏高 (高于 264V)。若电源电压偏高, 请在电压恢复正常后重新启动控制器。若电压恢复正常后, 启动控制器仍不能正常工作, 请更换控制器并通知厂方。
05	运行时过压	
06	电磁铁回路故障	关闭系统电源, 检查电磁铁连线是否正确, 是否有松动、破损等现象。若有则及时更换。确认无误后重启系统, 若仍不能工作, 可寻求技术支援。
07	电流检测回路故障	关闭系统电源, 30 秒后重新接通电源观察是否能正常工作。不行的话重试几次, 若该故障频繁出现, 需请求技术支援。
08	电机堵转	断开控制器电源, 检查电机电源输入插头是否脱落、松动、破损, 是否有异物缠绕在机头上。排除后重启系统仍不能正常工作, 请更换控制器并通知厂方。
09	制动回路故障	关闭系统电源, 检查电源板上白色的制动电阻接头是否松动或脱落, 将其插紧后重启系统。若仍不能正常工作, 请更换控制器并通知厂方。
10	HMI 通讯故障	检查控制面板与控制器的连线是否脱落、松动、断裂, 将其恢复正常后重启系统。若仍不能正常工作, 请更换控制器并通知厂方。
11	机头停针信号故障	检查机头同步信号装置与控制器的连线是否松动, 将其恢复正常后重启系统。若仍不能正常工作, 请更换控制器并通知厂方。
12	电机初始角度检测故障	请断电后再尝试 2~3 次, 若仍报故障, 请更换控制器并通知厂方。
13	电机 HALL 故障	关闭系统电源, 检查电机传感器接头是否松动或脱落, 将其恢复正常后重启系统。若仍不能正常工作, 请更换控制器并通知厂方。
14	DSP 读写 EEPROM 故障	请断电后再尝试 1 次, 若仍报故障, 请更换控制器并通知厂方。
15	电机超速保护	关闭系统电源, 30 秒后重新接通电源观察是否能正常工作。不行的话重试几次, 若该故障频繁出现, 请更换控制器并通知厂方。

16	电机反转	关闭系统电源， 30 秒后重启系统，若仍不能正常工作，请更换控制器并通知厂方。
17	HMI51 读写 EEPROM 故障	关闭系统电源， 30 秒后重启系统，若仍不能正常工作，请更换控制器并通知厂方。
18	电机过载	关闭系统电源， 30 秒后重启系统，若仍不能正常工作，请更换控制器并通知厂方。
19	少油报警	给针杆部分加油，并将 P22 参数设置为 4000，将上次加油后工作时间复位；也可以按 P 键关闭报警，继续使用。

386P00460

2011-10-13

A 版

# Contents

<b>Preface</b> .....	<b>1</b>
<b>Safety Instruction</b> .....	<b>1</b>
<b>1. Product Introduction</b> .....	<b>2</b>
1.1 Overview .....	2
1.2 Components& Accessories.....	2
1.3 Basic parameters .....	2
<b>2. Installation intructions</b> .....	<b>3</b>
2.1 Motor Intallation .....	3
2.2 Controller Installation .....	3
2.3 Controller shape dimension.....	3
2.4 Power Connection and Grounding .....	4
2.5 Defintion of controller interface.....	4
<b>3. Operation Instructions</b> .....	<b>5</b>
3.1 Operation Panel Instruction.....	5
3.2 Panel Keys Definition .....	5
<b>4. Optional User Mode</b> .....	<b>6</b>
4.1 Operator Mode .....	6
4.1.1 Sewing Mode Setup.....	6
4.1.2 start/end back tacking setup.....	6
4.1.3 Soft start setup: .....	7
4.1.4 Press foot lifting key: .....	7
4.1.5 Trimming key: .....	7
4.1.6 One-Shot-Sewing key.....	7
4.1.7 Stop position key.....	8
4.1.8 Lamp key: .....	8
4.1.9 Stitch compensation key.....	8
4.2 Technician Mode.....	8
4.3 Administrator Mode .....	11
4.4 Monitor mode .....	13
4.5 Wrong warning mode.....	13
4.6 Safety switch warning mode .....	13
<b>5. Operation after control system installation :</b> .....	<b>14</b>
<b>6. Control system restores storage parameter</b> .....	<b>14</b>
6.1 Restore storage parameter for factory of control .....	14
6.2 Restore default user's own parameter .....	14
<b>7. Recovery processing and maintenance</b> .....	<b>15</b>

## Preface





**CAUTION:**

**Please read this manual carefully, also with related manual for the machinery before use the controller. For installing and operating the controller properly and safely, qualified personnel are required.**

**This product is specified designed for sewing machines and must not be used for other purposes.**

**If you have any problem or any comment, please feel free to contact us.**

## Safety Instruction

- 1) Before installation and debugging, please carefully read the manual.
- 2) All the instruction marked with sign  must be absolutely observed or executed; otherwise, personal injuries or risk to the machine might occur.
- 3) This product should be installed and operated by persons with appropriate training only.
- 4) Before connecting power supply cords to power sources, it's necessary to make sure that the power voltage is in the range indicated on the product name plate.
- 5) Make sure to move your feet away from the pedals while power on.
- 6)  Turn off the power and remove plug prior to the following operations:
  - Connecting or disconnecting any connectors on the control box ;
  - Repairing or doing any mechanical adjustment ;
  - Threading needle or raising the machine arm ;
  - Machine is out of work.
- 7) Make sure to fasten all the fasteners firmly in the control boxes prior to the operation of the system.
- 8) Allow an interval of at least 30 seconds before repapering the system after power off.
- 9) Repairs and maintenance work may be carried out by special trained electronic technicians.
- 10) All the replacement parts for repairing must be provided or approved by the manufacturer.
- 11) The controller must be firmly connected to a properly grounded outlet.



**CAUTION :**

**Be sure to connect the controller to a properly grounded outlet. If the grounding connection is not secured, you may run a high risk of receiving a serious electric shock, and the controller may operate abnormally.**

# 1. Product Introduction

## 1.1 Overview

These series digital AC Servo System ,the motor and the controller are separately mounted on the same bracket, providing a very flexible mounting solution for customers. The system can be easily configured with different motors to match with various sewing machines, such as lockstitch, dual-needle lockstitch, heavy duty, and direct-driven sewing machines. The solenoid outputs are over current protected, preventing damage of the controller in case of mis-wiring of external accessories. Employing a switch-mode power supply for the sensitive control circuitry, the system can operate over a much wider voltage range. Side-mount connectors make the connection more reliable and reduce the malfunction caused by oil leakage.

## 1.2 Components& Accessories

The system contains main body and accessories. Main body of the system composes of control box (Fig.1-1).

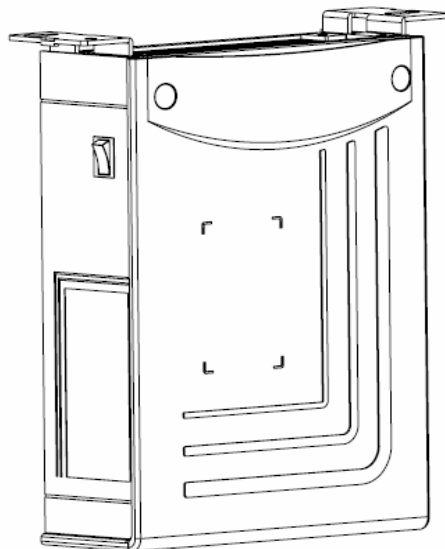

Fig.1-1 Control Box

controller provides the follow type of operation panel (see Fig.1-2)

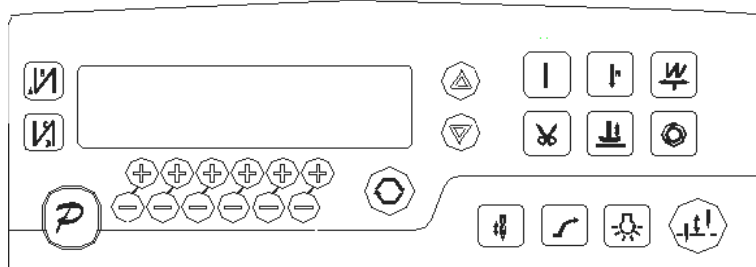

Fig.1-2 Panel

Please check whether the components listed on the packing list are all included. Please contact supplier for compensation in case of missing parts.

## 1.3 Basic parameters

Basic parameters of Digital AC Servo System (see table 1).

Table1:

Controller Type	P6AC50-2AF-001	P7AC50-2AF-001
Max. Sewing Speed (r/min)	5000	
Voltage Range	AC 220±20% V 50/60HZ	
Output Power	500W	
Max. Torque	3Nm	
Environment	0℃ — 40℃	
The motor way of transmission	Belt drive	Direct drive

## 2. Installation instructions

### Motor Installation

Step 1: Mount lifting bracket. When motor installed under the machine table, as needed, to drill holes in the following diagrams (see

Fig. 2-1 the example for USA base table) for the installation, mount lifting bracket.

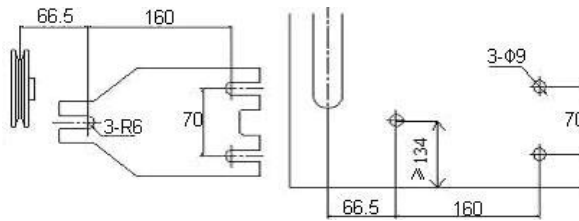

Fig. 2-1

Step 2: Install the motor (see Fig.2-2) and then tighten the lifting bracket.

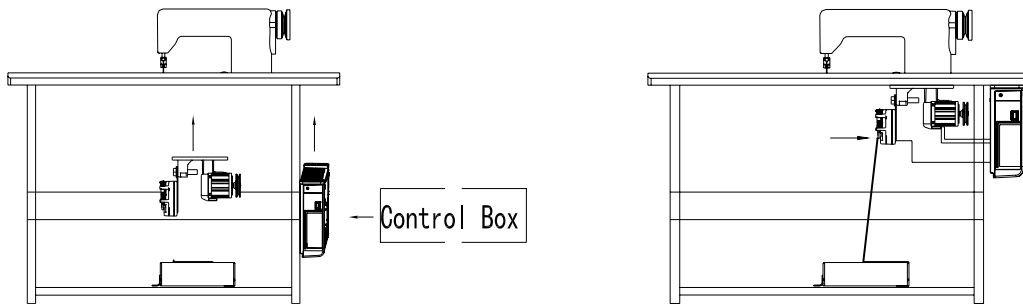

Fig. 2-2

### Controller Installation

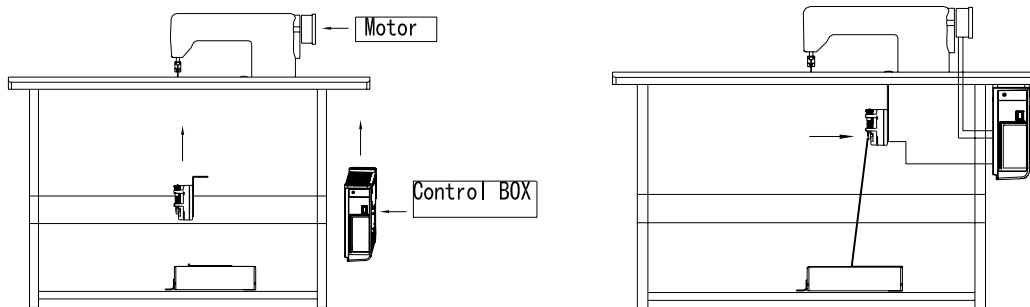

Fig. 2-3

### Controller shape dimension

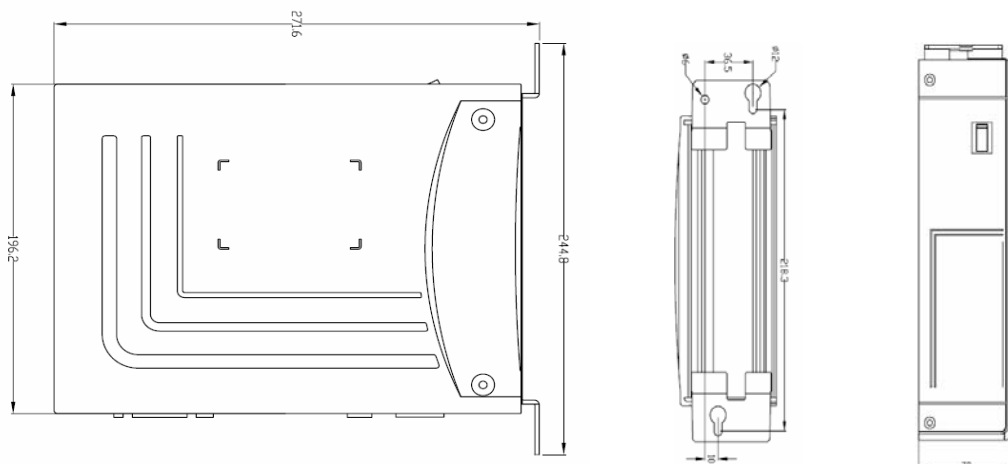

Fig. 2-4

## Power Connection and Grounding

Ground wire (Green/yellow) must be grounded. Use the correct connector and extension wire when connecting ground wire to Earth and secure it tightly (see Fig.3-1).

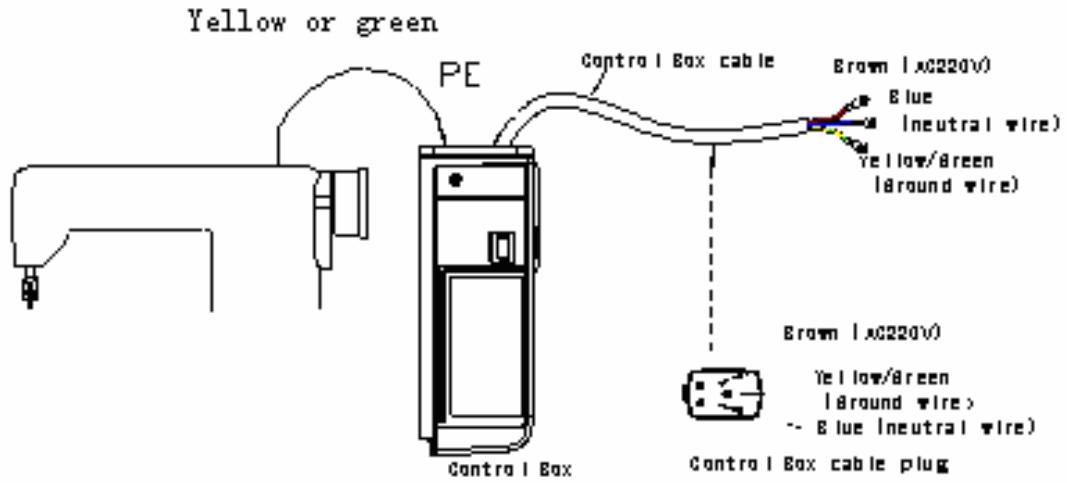



Fig. 3-1

 <b>CAUTION</b>	<p>Ensure all power cord, signal wire and grounding wire not be pressed by other matter or over-twisted, and not be too close to belt and belt wheel, keep 3cm-distance for safety.</p>
-----------------------------------------------------------------------------------------------------	-----------------------------------------------------------------------------------------------------------------------------------------------------------------------------------------

A 1Φ/220V power from a 3Φ/380V Power source Connection (See Fig.3-2):

 <b>CAUTION</b>	<p>If the system have no Neutral point, then this servo motor is not suitable for this connection.</p>
-------------------------------------------------------------------------------------------------------	--------------------------------------------------------------------------------------------------------

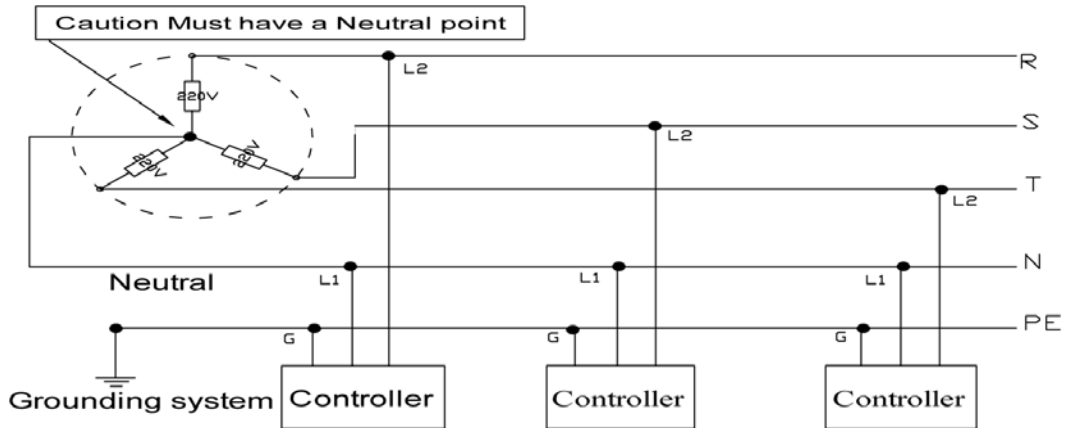

Fig. 3-2

## Definition of controller interface

Connections between control box and other accessories are illustrated in Fig.4-1. Plug these connectors into the corresponding sockets in control box.

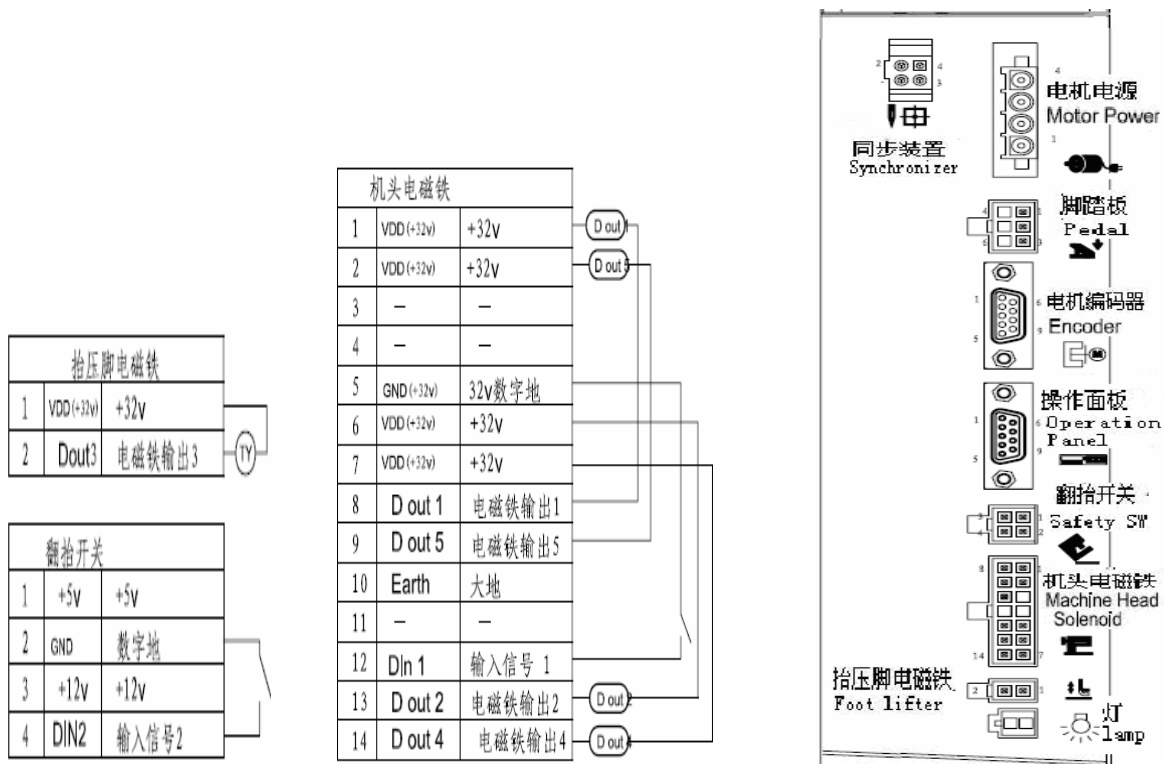

Fig. 4-1

**The drive ability of the LED :**

which the rated current is 20mA and the rated voltage is 3V.  
 Recommendatory LED diode parameter as follows:  
 VF : Min. = 3.0V, Max. = 3.6V (test condition IF = 20mA);  
 Peak Forward Current : Max. = 80mA;  
 Continuous Forward Current : Max. = 35mA

	<b>Caution:</b>	<b>Please check if all connectors match or not, pins are found right definition or not.</b>
--	-----------------	---------------------------------------------------------------------------------------------

### 3. Operation Instructions

#### 3.1 Operation Panel Instruction

Operation Panel is divided with two areas (See Fig3-1) : LCD display areas and key words area.



Fig.1-1

The LCD display areas are position in upper left of the whole operation panel. It including pattern, sewing mode, start/end back tacking, and foot lifter, stop-needles and trimming, and slow start operation set. The operation system automatically power on that HMI will a self-test, then all icons will flash once in the LCD display areas and only display the current settings of the system, the other did not choose that the icon will not be lighted, see figure 1-2.



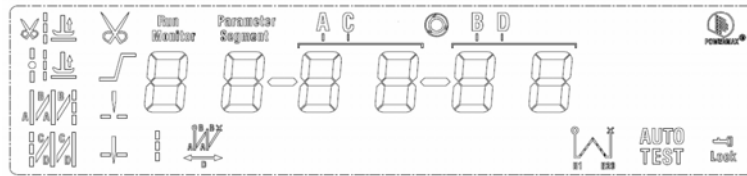

Fig.1-2

### 3.2 Panel Keys Definition

Operator panel for each key explanation see the table 1.

Table 1: Following form is the instruction of each key :

No	Appearance	Description
1		<b>Function key</b> : Major operation to determine and confirm working, and work with other key to set a higher level of the parameter.
2		<b>start back tacking key</b> : Every effective press the key once; round with single start back tacking, double start back tacking, four start back tacking and close start back tacking. The current status is displayed on the left of LCD. Detailed see "2.1.2 before and after sewing settings instruction.
3		<b>end back tacking key</b> : Every effective press the key once; round with single end back tacking, double end back tacking, four end back tacking and close end back tacking. The current status is displayed on the left of LCD. Detailed see "2.1.2 before and after sewing settings instruction.
4		<b>Free sewing mode key</b> : Every effective pushed the key once; the system selects free sewing mode. The free sewing status is displayed below LCD. Detailed see "2.1.1 model sets of sewing."
5		<b>Multi-segment sewing mode key</b> : Every effective pushed the key once; the system selects multi-segment sewing mode, pressed <b>P</b> key into the number of the needed setting. The multi-segment sewing status is displayed below LCD. Detailed see "2.1.1 model sets of sewing."
6		<b>W sewing mode key</b> : Every effective pushed the key once; the system selects W sewing mode. The <b>W</b> sewing status is displayed below LCD screen. Detailed see "2.1.1 model sets of sewing."
7		<b>Soft start key</b> : Select soft start function. It will show soft start status on top of LCD screen.
8		<b>Press foot lifting key</b> : Every effective pushed the key once; round with trimming after press foot lifting, sewing end press foot lifting and manual press foot lifting. The current status is displayed on top of LCD screen. Detailed see "2.1.4 press foot lifting set.
9		<b>Trimming key</b> : Select/Cancel automatic trimming. The trimming status is displayed on top of LCD screen. Detailed see "2.1.5 trimming set.
10		<b>One-Shot-Sewing key</b> : Select/Cancel one-Shot-Sewing, it is effective only into multi-segment sewing mode, when chose one-shot sewing, one-shot foot pedal can complete one needle of multi-segment sewing ; The one-shot-sewing status is displayed on top of LCD screen.
11		<b>Stop position key</b> : Select up/down stop position. The up/down stop position is displayed on top of LCD screen. Detailed see "2.1.7 stop position set. [Note: automatic trimming back, the system is always on the up of needle position.]
12		<b>Lamp key</b> : Select switch on/off lamp. When floodlights are light and HMI supply 5V lamp light.
13		<b>Stitch compensation key</b> : Start stitch compensation if press, stop stitch compensation if loose.
14		<b>Temporary accelerate speed key</b> : Press the button to temporary increased sewing speed.
15		<b>Temporary deceleration speed key</b> : Press the button to temporary reduced sewing speed.
16		<b>Parameter/Index accelerate key</b> : Press the button to increased parameter value/index.
17		<b>Parameter/Index decelerate key</b> : Press the button to reduced parameter value/index

## 4. Optional User Mode



### 4.1 Operator Mode











In this mode, various sewing modes are available after technical parameters settings. As the default setting, the system enters this











mode when it starts. Under this mode, such basic functions as normal sewing work and modes change can be realized but no change inside parameters and setting.

Note: During working, if long time without press button, HMI will change to idle status automatically, and will cancel the operation before.

#### 4.1.1 Sewing Mode Setup

**Free sewing mode:** Press  key, free sewing mode icon  is lightened in LCD area. LCD  indicates free sewing mode has been selected; it is ready just step the pedal for operation.





**Multi-segment sewing mode:** Press  key, constant-stitch sewing icon  is lightened in LCD area. LCD  is multi-segment sewing status. Use the last  and  key to choice the N segment, and press  key to entry multi-segment sewing stitch number of each segment setup status . You may use the third and the fourth  and  to choice the need to modify number of segment, use the fifth and sixth  and  to modify number of needle in multi-segment sewing stitch setup status.

**W sewing mode:** Press  key, constant-stitch sewing icon  is lightened in LCD area. LCD  is W sewing setup status. You may use the third and the fourth  and  to choice needle in A area and set rang 1-99 stitches; use the fifth and sixth  and  to choice needle in B area and set rang 1-99 stitches. Press  key, can be used to choice A B D segment, LCD , use the fifth and sixth  and  to choice needle in B area and set rang 1-99 stitches.



#### 4.1.2 start/end back tacking setup

Step 1: Press  key

Start back tacking has following four modes:



- ◆  None start back tacking
- ◆  Single start back tacking
- ◆  Double start back tacking
- ◆  Four start back tacking

Step 2: Stop pressing to confirm, then this back tacking mode has been selected.





Step 3: Change the corresponding parameters (A and B values) by using  and  key, the value range is 1-99 stitches. It set pin number to be completed before star back tacking.

**Note: End back tacking setting method is similar with start back tacking setting method basically, except the key.**



#### 4.1.3 Soft start setup :

Press  key, entry into soft start status. If choice soft starts, the icon  is lightened in LCD areas. Press this key again to exit soft start status, the icon  will off.

#### 4.1.4 Press foot lifting key :

Press  key, entry into foot lifting status, total four different status, no automatic foot lifting, automatic foot lifting after trimming ()、 automatic foot lifting if stop during sewing ()、 automatic foot lifting if trimming and stop during sewing. Use  key to choice foot lifting setup status and stop press key to confirm. Foot lifting had compiled.

#### 4.1.5 Trimming key :





If press  key entry into press trimming status, select/non-select trimming. Press  key repeat, the icon  is lightened/disappeared in LCD area. Whether it choice trimming that the icon is lightened or disappeared.

#### 4.1.6 One-Shot-Sewing key

Use  key: select/non-select one-shot-sewing statuses. The icon  will light if select one-shot-sewing in LCD areas, press  will

disappear.

#### 4.1.7 Stop position key

Use  key: select up/down stop position. Press  key repeat, between up /down  stop position to switch. Choose need to stop position and stop press key to confirm. Stop position had compiled.

#### 4.1.8 Lamp key :



Use  key: select switch on/off lamp which was powered by the operation panel.



#### 4.1.9 Stitch compensation key



Use  key: press this key to start stitch compensation. Compensation half needle or a half needle due to the press time. If you keep press that compensation needle always until release button.

## 4.2 Technician Mode

In this mode, technical parameters corresponding to various functions can be adjusted or reset according to practical needs so that the system may run in the best condition. Parameters setting under technician mode:

Step 1: Under operator mode, press  key and  key, the LCD will display psd-0000, and then set the password by administrator.

Step 2: Use the last four  keys and  keys to input the password, and then press  key. If the password is correct then enter technician mode, otherwise, it will return to operator mode.

Step 3: Change technician parameters by the second and the third  key and  keys. The parameters are shown in table 2.

Step 4: Parameters values can be changed by the last four  keys and  keys.

Step 5: Under technician mode, press  key, the panel will return to operator mode.

Table 2: Technician mode parameter:

	Parameter High byte	Parameter Low byte	Default	Rang	Comment
speed	0	0	200	100 ~800	Minimum sewing speed
		1	4000	200 ~5000	Maximum sewing speed
		2	3000	200 ~5000	Maximum constant sewing speed
		3	4000	200 ~5000	Maximum manual back tacking speed
		4	200	100 ~800	Stitch compensation speed
		5	250	100 ~500	Trimming speed
		6	0	0 / 1	Soft start Mode setup: 0: Soft start only after trimming 1: Soft start after both trimming and stop
		7	2	1 ~9	Soft start stitch number
		8	200	100 ~800	Soft start speed
		9	20	1 ~20	System accelerate sensitivity ( Direct drive transmission can be set up to a large value ; belt transmission don't set large value or too much noise and vibration. This parameter do not affect the electrical)
	A	20	1 ~20	System decelerate sensitivity ( Direct drive transmission can be set up to a large value ; belt transmission don't set large value or too much noise and vibration. This parameter do not affect the electrical )	
Back tacking setup	1	0	1800	200 ~2200	Start back tacking speed
		1	1800	200 ~2200	End back tacking speed
		2	1800	200 ~2200	Continuous back tacking speed
		3	24	0 ~70	Start back tacking stitch compensation 1

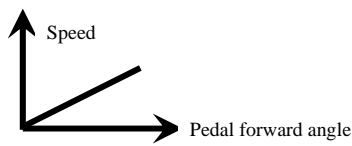
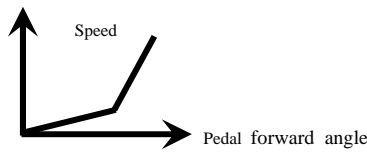
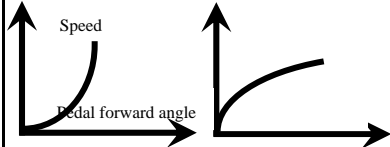
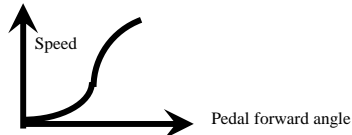
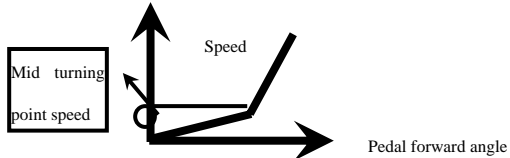
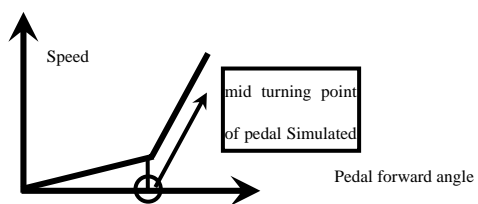
	Parameter High byte	Parameter Low byte	Default	Rang	Comment
		4	20	0 ~70	Start back tacking stitch compensation 2
		5	24	0 ~70	End back tracking stitch compensation 1
		6	20	0 ~70	End back tracking stitch compensation 2
Pedal	3	0	0	0 / 1 / 2 / 3	Pedal Curve mode setup: 0: Auto Calculated liner Curve (According to the highest speed automatic computation) 
1: Two segment liner Curve. (You shall be free to set slow start after fast or fast start after slow, the parameters "31" and "32" cooperate with use ) 					
2: Arithmetic Curve ( the parameters [33] cooperate with use ) 					
3: S curve (the operate control is very well, slow start after fast ) 					
		1	3000	200 ~4000	Two segment controls the speed slope: mid turning point speed RPM (two segment of turning point speed) , the parameter[30] set to 1 effective. 
		2	800	0 ~1024	Two segment controls the speed slope: mid turning point of pedal Simulated value, the parameter[30] set to 1 effective, the value is between[38]and[39]. 

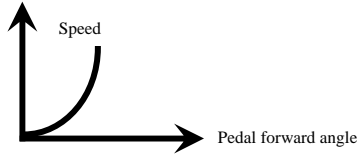
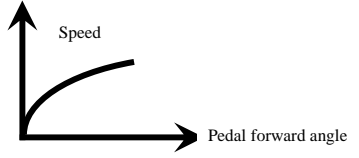
	Parameter High byte	Parameter Low byte	Default	Rang	Comment
		<b>3</b>	2	1 / 2	Arithmetic Curve supplementary parameter : the parameter[30] set to 2 effective, 1: Square (the low speed control is very well, slow start after fast) ; 
					2: Square root (Responding speed is fast, fast start after slow) ; 
		<b>4</b>	90	0 ~ 1024	Pedal trimming position set, See 2-1. (the value is not higher than the parameter [30])
		<b>5</b>	300	0 ~ 1024	Press foot lifting, See 2-1. (the value is between[34]and[36].)
		<b>6</b>	419	0 ~ 1024	Pedal back mid position, see 2-1. (the value is between[35]and[37].)
		<b>7</b>	510	0 ~ 1024	Pedal step upon running position, see 2-1. (the value is between[36]and[38])
		<b>8</b>	578	0 ~ 1024	Pedal low speed running position (upper) , see 2-1 (the value is between[37]and[39])
		<b>9</b>	962	0 ~ 1024	Pedal simulation the largest of value, see 2-1 (the value is not lower than the parameter [38])
		<b>A</b>	100	0 ~ 800	Pedal press foot lifting confirm time
custom setup	<b>4</b>	<b>0</b>	1	0 / 1	Run to up needle position after Power on: 0: no action 1: action
		<b>1</b>	1	0 / 1	Automatically reinforcing functions chose : (the machine head is not automatically reinforcing functions, the best way is prohibit) 0: prohibit 1: allow
		<b>2</b>	0	0 / 1	Back to sewing by hand when the function mode selection: 0: Juki mode. In sewing or in the end of the action 1: Brother mode. It acts only in sewing.
		<b>3</b>	0	0 / 1 / 2 / 3	Special Running Mode setup: 0: operator select 1: simple sewing mode 2: calculate initial angle of motor (do not uninstall strap) 3: calculate motor/machine head run rate mode (synchronizer, do not uninstall strap)

	Parameter High byte	Parameter Low byte	Default	Rang	Comment
		4	0	0—31	Torque boost up at low speed : 0: no action 1~31: 31 levels Torque boost up
		5	1	0 / 1	Stop pin mode: 0: Constant speed tackle mode (in the belt transmission, Parking is not precision) 1: back pull mode (PMX)
		6	100	0 ~800	Command button to fill half-needle time
		7	150	0 ~800	Command button to fill a needle time
Operation	6	1	0	0 / 1 / 2	Translating Parameter 0: no action 1: Download parameters( the panel will parameter from panel to controller ) 2: Upload parameters ( the panel will parameter from controller to panel)
		2	0	1, 2, XXXX	Restore storage parameter(Only restore parameters to operators, and vendors and maintenance ) Belt flat 1000/ Direct drive flat 2000
		3	0	1, 2	Backup current parameter as user parameter for restore (restore)
		Note: Above such "6x "parameter to operate is not saved.			

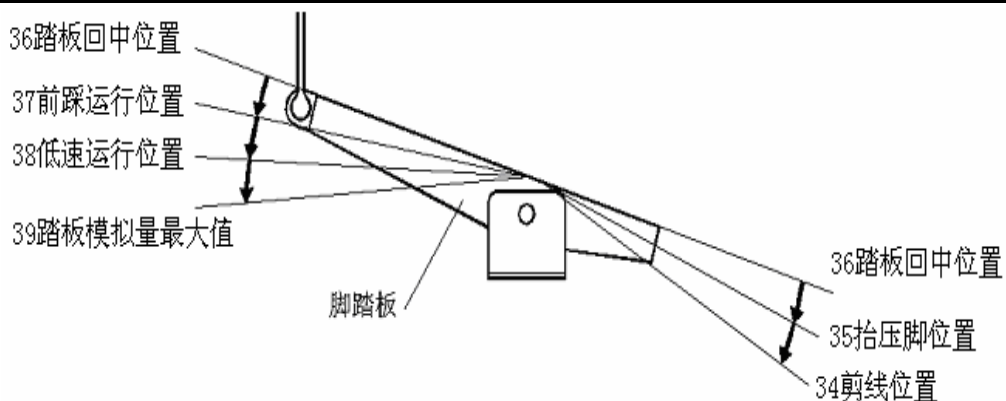

Fig2-1 Pedal action parameter the position of the diagram

### 4.3 Administrator Mode

In this mode, various solenoid parameters set can be regulated according to the practical need so that the servo system can normally run on every sewing machine. Parameters setting under technician mode:

- Step 1:** Under operator mode, press **P** and **Q** keys to enter administrator mode in LCD PD-0000.
- Step 2:** The password is entered using the last four **+** keys and **-** keys, then press **P** key. If the password is correct, enter into the technician mode, or return to the operator mode.
- Step 3:** Change administrator parameters index by the second and the third **+** key and **-** key under administrator mode. The details of technician parameters are shown in table3.
- Step 4:** Parameters values can be changed by the last four **+** keys and **-** keys.
- Step 5:** Under administrator mode, press **P** key, the panel will return to operator mode.

Table 3: Administrator mode parameter:

	Parameter High byte	Parameter Low byte	Default	Rang	Comment			
Trimming mode	0	2	1	0 / 1 / 2 / 3	Mode selection for trimming sequence. 0: According to the parameters 【03】 set angles is trimming, until up position delayed 【06】 time off. 1: According to the parameters 【03】 set angles is trimming, until 【04】 set angles off. 2: According to the parameters 【03】 set angles is trimming, it delayed 【06】 off. 3: Down position signal delayed the parameter 【05】 set angles is trimming, it delayed 【06】 off.			
					3	10	5 -359	The start angles of trimming (relative down position of angle)
					4	120	10 -359	The end angles of trimming (relative down position of angle, Need to greater than the system of parameters 【03】 )
					5	10	1 -999	Trimming start delay time T1 (ms)
					6	60	1 -999	Trimming end delay time T2 (ms)
					Tension release 、Wiper and Clamp mode	1	0	0
1	25	5 -359	The start angles of tension release(relative down position of angle)					
2	350	10 -359	The end angles of tension release (relative down position of angle, Need to greater than the system of parameters 【11】 )					
3	1	1 - 999	Tension release solenoid start delay timeT1 (ms)					
4	10	1 - 999	Tension release solenoid up position delay time T2 (ms)					
5	1	0 / 1	selection for Wiper function 0: off 1: on					
6	10	1 - 999	Clamp /Wiper delay time ms					
7	70	1 - 9999	Clamp /Wiper holding time ms					
8	50	1 - 999	Clamp /Wiper revert time ms					
9	0	0 / 1	Thread Clamp function: 0: off 1: on					
10	70	0 - 359	Clamp start angle					

	Parameter High byte	Parameter Low byte	Default	Rang	Comment
		11	140	0 - 359	Clamp end angle
Stop mode	3	1	0	0 / 1	The automatic test mode selection : 0: order stitches 1: order time
		2	300	0 ~1000	The safety SW alarm confirm time ms(the same way does not distinguish between direct-drive safety SW and flat lock trim of protection SW)
		3	50	0 ~1000	The safety SW restore confirm time ms
		4	0	0 / 1	Motor rotation direction setup: 1: Forward 0: Reverse
Machine head parameter	4	0	1000	0 - 9999	motor/machine head run rate: 0.001 (if automatic calculation of motor/machine head run rate has done, the Parameter value in control box maybe different with that in HMI)
		2	0	0 - 359	Up needle position adjusted angle (compare to up position sensor position excursion)
		3	155	0 - 359	Down needle position mechanical angle
		4	200	0 - 800	Press down delay time(ms)

#### 4.4 Monitor mode





During HMI idle, Press  key, then press  key, entry monitor mode. Use the first and second ( and ) key to switch to watch the parameters. About the monitor parameter, please refer the sheet 4, HMI will back to idle if no wheel or no press the key in regulates time.

Table 4: monitor mode parameter

	Parameter High byte	Parameter Low byte	unit	comment
Monitor status	1	0		Counter stitches
		1		Counter trimming
	2	0	V	DC Bus Voltage
		1	RPM	Motor speed
		2	0.01A	One phase current
		3	degree	Initial angle
		4	degree	Mechanical angle
		5	---	Sampling value of pedal voltage
		6	0.001	motor/machine head run ratio
		7	hour	Motor total run time
	8	---	Sampling value of potentiometer at machine head	
	3	0 - 7	---	History Error Code Recorder 8



## 4.5 Wrong warning mode

If the HMI detects something wrong from controller, it will jump automatically to warning mode, and show error code by 8-segment. see . During wrong warning mode, the user can set technician parameter change, administrator parameter and HMI parameter self-change or monitor mode. Exit these modes not back to idle but back to wrong warning mode. It will return normal status after fixing error and resetting power.

## 4.6 Safety switch warning mode

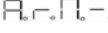
If HMI test safety switch warning, it will jump automatically to safety switch warning mode, see . During wrong safety switch warning mode, the user can set technician parameter, administrator parameter and HMI parameter self-change or monitor mode. Exit these modes not back to idle but back to wrong warning mode. (The P reunification with the switch input, does not distinguish between safety switch, scissors protection switch)

## 5. Operation after control system installation :

1、 after control system installation, one 'automatic calculate **motor/machine head run rate**' need work. ( because of machining precision, different plant have different effective radius of engine hand-wheel, even direct drive do not have 1:1“**motor/machine head run rate**”). Entry **technician** parameter No.43, setup this parameter as 3. Press pedal forward, system work with middle speed about 10cycles and stop, the result of calculation save in control box. Then restore technician parameter No.43 to 0.

If can confirmation the value of “**motor/machine head run rate**”, can setup **administration** parameter No.40 directly. Real “**motor/machine head run rate**” in control box can read by **monitor** parameter No.26.



2、 New control system in the needle position stop no longer rely on sensor signal to determine the down-stop needle, but by **administration** parameter No.43, this parameter confirms the mechanical angle from down needle position to up needle position. Current mechanical angle can read by **monitor** parameter No.24, mechanical angle of up needle position is 0. (**After power on , control system will work at least one time by up needle position to revise mechanical angle, for example: Round to up needle position. Value of “motor/machine head run rate” will effect the calculation of mechanical angle. Suggest adjust down needle position after confirm right “motor/machine head run rate”.**





3、 New control design used to 5 solenoid drive output. Each drive output can setup its function freely. **Before use please confirm if the administrator 6x parameter setup the function of each driver output same as the connection with solenoid; and confirm administrator 7x 8x parameter, otherwise perhaps happen solenoid power not enough.** (the default parameter is according to normal solenoid connection)



## 6. Control system restores storage parameter

### 6.1 Restore storage parameter for factory of control

Step 1: Under operator mode, press  and  keys, LCD PD-0000; user type the passport.

Step 2: The password is entered using the last four  keys and  keys. If the password is correct, enter into the technician mode, or return to the operator mode.



Step 3: Change administrator parameters index to **【62】** by the first and the second  key and  key under administrator mode, then press  key to set parameter. Restore storage parameter for factory of control can be changed by the last four  keys and  keys, Usually it's four bit.



Step 4: the parameter confirms correct, press  key until the red light of HMI are bright or buzz produces a long loud, release  key, HMI and the whole system restore storage parameter.

### 6.2 Restore default user's own parameter

The parameter **【63】** of HMI can be used to set the customer' s own parameters, following methods of operation :

Step 1: Under operator mode, press  and  keys, LCD PD-0000; you required to type the passport.

Step 2: The password is entered using the last four  keys and  keys, then press  key. If the password is correct, enter into the technician mode, or return to the operator mode.

Step 3: Change administrator parameters index to **【62】** by the first and the second  key and  key under administrator

mode. The value is changed 1 or 2 by the last **+** keys and **-** keys.

**Note:** when it set 1, the follow-up to the user to customize the parameter is used 1; when it set 2, the follow-up to the user to customize the parameter is used 2.

Step 4: Press **P** key keep 5 second, HMI and the whole system will the current parameter set restore the user to customize storage parameter.

When the parameter cause to the control system error, the user can restore the custom of the parameters, the methods of operation as “4.1 Restore storage parameter for factory of control”. The parameter **【62】** is changed 1 or 2, Press **P** key keep 5 second again, the system will restore the user to customize storage parameter.

**Note:**

- 1、 After power on, HMI 50 only download **operator mode** parameter, but not **technician** and **administrator** parameter. If all parameter is needed, **technician** parameter 61 can used to download all current working parameter of HMI 50.
- 2、 If restore other parameter of HMI50 storage, **technician** 62 can be used to make it current working parameter, and download initiative.
- 3、 After single parameter modification, HMI will download the value that is different with old value of parameter.
- 4、 Recover default parameters, the system the best in the clear once again.

## 7. Recovery processing and maintenance

error code	meaning	solution
01	hardware overflow	Turn off the system power, restart after 30 seconds, if the controller still does not work, please replace it and inform the manufacturer.
02	software overflow	
03	system under-voltage	Disconnect the controller power and check if the input voltage is too low (lower than 176V). If yes, please restart the controller when the normal voltage is resumed. If the controller still does not work when the voltage is at normal level, please replace the controller and inform the manufacturer.
04	over-voltage when the machine is off	Disconnect the controller power and check if the input voltage is too high (higher than 264V). If yes, please restart the controller when the normal voltage is resumed. If the controller still does not work when the voltage is at normal level, please replace the controller and inform the manufacturer.
05	over-voltage in operation	
06	solenoid circuit failure	Turn off the system power, check if the solenoid is connected correctly and if it is loose or damaged. If yes, replace it in time. Restart the system upon making sure everything is in good order. If it still does not work, seek technical support.
07	electrical current checking circuit failure	Turn off the system power, restart after 30 seconds to see if it works well. If not, try several more times. If such failure happens frequently, seek technical support.
08	locked motor roller	Disconnect the controller power, check if the motor input plug is off, loose or damaged, or if there is something twined on the machine head. After checking and correction, if the system still does not work, please replace the controller and inform the manufacturer.
09	brake circuit failure	Turn off the system power, check if the white brake resistance plug on the power board is loose or dropped off, fasten it and restart the system. If it still does not work, please replace the controller and inform the manufacturer.
10	HMI communication failure	Check if the connecting line between control panel and controller is off, loose or broken, restore it and restart the system. If it still does not work, please replace the controller and inform the manufacturer.
11	machine head needle positioning failure	Check if the connection line between machine head synchronizer and controller is loose or not, restore it and restart the system. If it still does not work, please replace the controller and inform the manufacturer.
12	motor original angle checking failure	Please try 2 to 3 more times after power down, if it still does not work, please replace the controller and inform the manufacturer.
13	Motor HALL failure	Turn off the system power, check if the motor sensor plug is loose or dropped off, restore it and restart the system. If it still does not work, please replace the controller and inform the manufacturer.

14	DSP Read/Write EEPROM failure	Try another time after power down, if it still does not work, please replace the controller and inform the manufacturer.
15	Motor over-speed protection	Turn off the system power, turn on again in 30 seconds to see if it works. If not, try several more times, if such failure happens frequently, please change the controller and inform the manufacturer.
16	Motor reversion	Turn off the system power, restart the system after 30 seconds, if it still does not work, please replace the controller and inform the manufacturer.
17	HMI51 Read/Write EEPROM failure	Turn off the system power, restart the system after 30 seconds, if it still does not work, please replace the controller and inform the manufacturer.
18	Motor overload	Turn off the system power, restart the system after 30 seconds, if it still does not work, please replace the controller and inform the manufacturer.
19	Lack of oil alarm	Add oil to the needle rod, and set the P22 parameter at 4000, resume the working time after the last oil adding; or you can press button P to close the alarm and continue to use.

386P00460

2011-10-13

A 版