

---

# AH 系列数控交流伺服系统

## AH Series AC Servo System

工业缝纫机伺服控制器

Industrial sewing machine servo controller

使用说明

User manual

上海鲍麦克斯电子科技有限公司

---

# 目 录

1 产品安装.....	1
1.1 产品规格 .....	1
1.2 接口插头的连接.....	1
1.3 连线与接地.....	2
2 操作面板使用说明 .....	3
2.1 H-70 操作面板的显示说明.....	3
2.2 操作面板各按键功能说明 .....	4
3 系统参数设置说明 .....	6
3.1 技术员参数表 .....	6
3.2 系统员参数表 .....	10
3.3 监控参数表操 .....	15
3.4 安全报警 .....	15
3.5 故障代码表.....	16
4 特殊功能操作说明 .....	17
4.1 上停针位调整 .....	17
4.2 一键恢复机头厂家参数值 .....	17
4.3 脚踏板灵敏度调整 .....	18
4.4 电磁铁性能调整.....	19
4.5 前后固缝模式设置 .....	19
4.6 前后固缝与四段缝超长针数设置.....	20
4.7 H-70 操作面板计针数/计件数功能.....	21

## 安全事项

- 在使用本产品之前，请先阅读《产品说明书》及所搭配的缝纫机机械说明书。
- 本产品必须由接受过专业培训的人员来安装或操作。
- 请尽量远离电弧焊接设备，以免产生的电磁波干扰本控制器而发生误动作。
- 请不要在室温 45° 以上或者 0° 以下的场所使用。
- 请不要在湿度 30% 以下或者 95% 以上或者有露水和酸雾的场所使用。
- 安装控制箱及其他部件时，请先关闭电源并拔掉电源插头。
- 为防止干扰或漏电事故，请做好接地工程，电源线的接地线必须牢固的方式与大地有效连接。
- 所有维修用的零部件，须由本公司提供或认可，方可使用。
- 在进行任何保养维修动作前，必须关闭电源并拔掉电源插头。控制箱里有高压危险，必须关闭电源五分钟后方可打开控制箱。
- 本手册中标有  符号之处为安全注意点，必须注意并严格遵守，以免造成不必要的损害。

## 1 产品安装

### 1.1 产品规格

产品型号：AHU58A-55/AHD58A-55；电源电压：AC 220 ± 20% V；电源频率：50Hz/60Hz；最大输出功率：550W。

### 1.2 接口插头的连接

将脚踏板及机头的各连接插头安插到控制器后面对应的插座上，各插座名称如图 1-2 所示。连接好，请检查插头是否插牢。





图 1-1 AH 系列控制器图

① 电机电源插座；② 脚踏板插座；③ 电机编码器插座；④ 操作面板插座；⑤ 翻台开关插座；⑥ 自动电磁铁插座；⑦ 抬压脚电磁铁插座；⑧ 机头灯插座（黑色）；⑨ 外置同步器插座

：使用正常的力量插不进去时，请检查插头与插座是否匹配，插入方向或针的方向是否正确！  
照明灯接口和抬压脚电磁铁接口都是 1\*2 的接口，机头照明灯接口使用黑色接口，请注意区分。

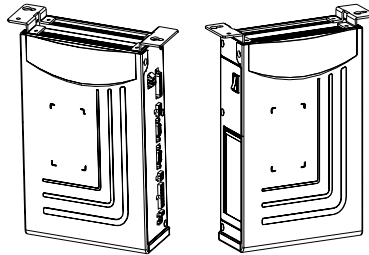

图 1-2 AH 系列控制箱插座背板



图 1-3 控制器接口定义

### 1.3 连线与接地

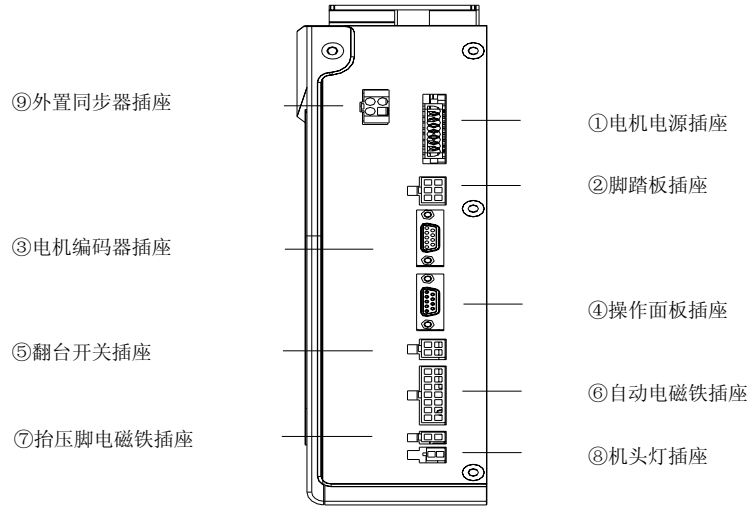
必须要做好系统的接地工程，请合格的电气工程人员予以施工。产品通电及投入使用前，必须确保电源插座 AC 输入端已安全可靠地接地。系统的接地线为黄绿线，该地线请务必可靠连接至电网安全保护接地上，以保证安全使用，并可防止出现异常情况。

**⚠️：所有电源线、信号线、接地线等接线时不要被其它物体压到或过度扭曲，以确保使用安全！**

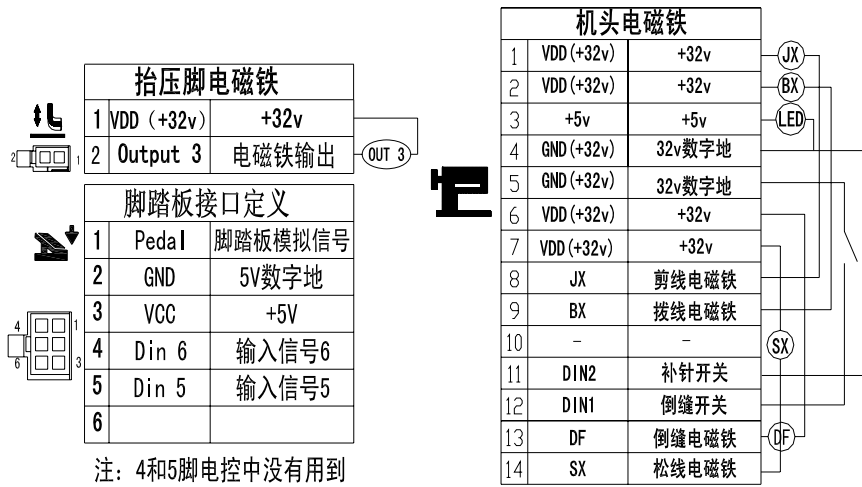
## 2 操作面板使用说明

### 2.1 H-70 操作面板的显示说明

根据系统工作状态，操作面板的液晶屏模块将显示当前的缝纫模式、各种参数、前/后固缝设置，以及抬压脚、停针位、剪线、慢速起缝等液晶字符。



图 2-1 操作面板 H-70 外观界面



图 2-2 H-70 操作面板液晶显示屏图示

表 2-1 H-70 操作面板液晶功能图标显示说明

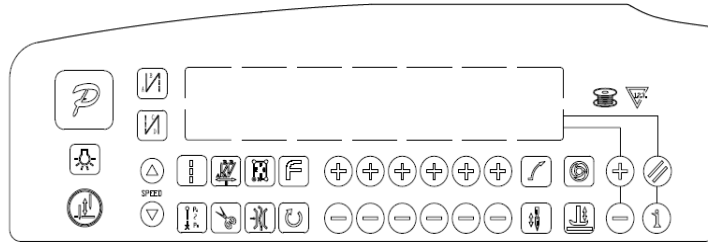
索引	图标	描述	索引	图标	描述
1		自动剪线功能	12		W 缝
2		软启动功能	13		多段缝
3		前加固缝	14		多段缝触发功能
4		后加固缝	15		自动测试
5	AE BFCGDH	缝纫段数标记	16		夹线功能
6		计数/参数值显示	17		四段缝
7		剪线后抬压脚	18		计针标记
8		中间停针抬压脚	19		计件标记
9		中间停针下停针	20		计数显示
10		中间停针上停针	21		速度标记
11		自由缝			

## 2.2 操作面板各按键功能说明

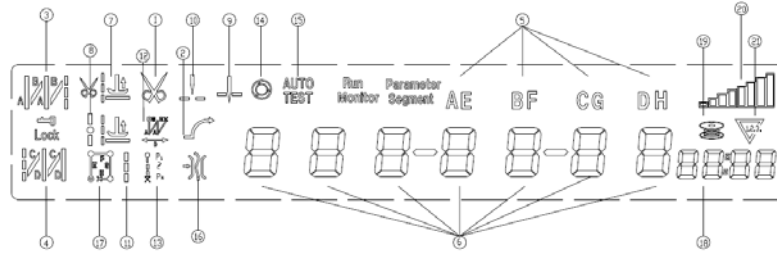
表 2-2 H-70 按键功能介绍

序号	外观	名称	功能描述
1		确认及返回键	按键输入参数确认键，并回退到上一级菜单直至操作员缝纫工作状态。此外，还可与其它按键同时按下实现组合功能，可进入高级参数与功能设置。
2		前加固缝键	亦称为起始倒针功能选择键，每按动一次，系统前固缝工作模式将按照 11B 号参数设置在无前固缝与前单固缝 <sup>B</sup> 、前双固缝 <sup>A</sup> 、前四固缝 <sup>A</sup> 之间循环选择，对应液晶屏图标点亮。同时显示 <sup>A</sup> 4 <sup>B</sup> 即为前固缝界面，选择对应的 <sup>+</sup> 键和 <sup>-</sup> 键可增减设置 A、B 段的针数，默认针数范围 1~F 对应 1~15 针。
3		后加固缝键	亦称为结束倒针功能选择键，每按动一次，系统后固缝工作模式将按照 11B 号参数设置在无后固缝与后单固缝 <sup>C</sup> 、后双固缝 <sup>D</sup> 、后四固缝 <sup>D</sup> 之间循环选择，对应液晶屏图标点亮。同时显示 <sup>C</sup> 4 <sup>D</sup> 即为后固缝界面，选择对应的 <sup>+</sup> 键和 <sup>-</sup> 键可增减设置 C、D 段的针数，默认针数范围 1~F 对应 1~15 针。
4		自由缝键	按下该键，系统即进入自由缝工作模式，对应液晶屏图标 <sup>I</sup> 被点亮，踩下踏板即可开始缝纫。
5		W 缝键	按下该键，系统即进入 W 缝工作模式，对应液晶屏图标 <sup>W</sup> 被点亮，同时显示 <sup>A</sup> 4 <sup>B</sup> <sup>D</sup> 即为 W 缝界面，选择对应的 <sup>+</sup> 键和 <sup>-</sup> 键可增减设置 A、B、D 段的针数，默认针数范围 1~F 对应 1~15 针。
6		多段缝键	亦称为定长缝，按下该键，系统即进入多段缝工作模式，对应液晶屏图标 <sup>I</sup> 被点亮，同时显示 <sup>P</sup> 0 <sup>4</sup> 0 <sup>1</sup> 1 <sup>6</sup> 即为多段缝界面，图中 <sup>P</sup> 0 <sup>4</sup> 为总段数，可用 <sup>▲</sup> 键和 <sup>▼</sup> 键增减调整，默认最大 24 段， <sup>-</sup> 0 <sup>1</sup> 为当前设置段， <sup>-</sup> 1 <sup>6</sup> 为当前段的缝制针数，这些数字均可通过对应的 <sup>+</sup> 键和 <sup>-</sup> 键增减调整。
7		四段缝键	按下该键，系统即进入四段缝工作模式，对应液晶屏图标 <sup>E</sup> 被点亮，同时显示 <sup>E</sup> 4 <sup>F</sup> 4 <sup>G</sup> 4 <sup>H</sup> 即为四段缝界面，选择对应的 <sup>+</sup> 键和 <sup>-</sup> 键可增减设置 E、F、G、H 段的针数，默认针数范围 1~F 对应 1~15 针。
8		软启动键	按下该键，液晶屏图标 <sup>↷</sup> 亮，表明软启动有效，再按一下该图标熄灭，表明关闭软启动功能。

序號	外觀	名稱	功能描述
9		夹线键	按下该键，液晶屏图标  亮，表明夹线功能有效，再按一下该图标熄灭，表明关闭夹线功能。
10		停针位键	用于缝纫中途停车时系统的上/下停针位置选择，按下该键，  点亮，表明为上停针，再按下该键，  点亮，表明为下停针。但缝纫完成剪线之后，系统将停车在上针位。 注：H-43 面板无此按键，通过组合键  +  实现此功能。
11		补针键	在自由缝中途停车或多段缝段间停车时，按下该键可实现补针功能。点动按键为补半针，按下时间稍长为补一针，保持按下则连续补针。
12		自动剪线键	按下该键，液晶屏图标  点亮，表明自动剪线功能有效，再按一下该图标熄灭，表明关闭剪线功能。
13		抬压脚键	每按动一次，系统抬压脚模式将在不自动抬压脚、剪线后自动抬压脚  、缝纫中停车自动抬压脚  、剪线后和停车时都自动抬压脚四种模式之间循环选择，对应液晶屏图标同时点亮。
14		多段缝触发键	在多段缝和四段缝模式下，按下该键，液晶屏图标  点亮，表明选择触发模式有效，此时点动脚踏板一次即可完成当前段的设定针数缝制；再按一下该图标熄灭，表明多段缝下触发功能关闭。
15		机头灯键	H-43 与 H-70 面板支持外接机头灯调光功能，依次按下该键，可获得关闭和从暗到明四级调光效果。
16		自定义功能键	自定义扩展功能键，根据情况可扩展为与其它按键同时按下实现组合功能。
17		速度增减键	可快速调整系统的最高转速。在多段缝模式下，亦为总段数的调整按键。此外，在参数设置时，可作为对应参数号的调整按键。
18		参数增减键	调整对应数值的增加键与减小键。
19		切换键	快捷切换操作，目前保留，暂未使用。
20		计数切换键	计针数模式与计件数模式的计数切换键。
21		计数清零键	计针模式与计件模式下当前计数清零按键。

### 3 系统参数设置说明

#### 3.1 技术员参数表

<p>1、先按住 <b>[P]</b> 键，后按下 <b>[↓]</b> 键，可修改技术员参数表；</p> <p>2、液晶显示屏显示 <b>P d-0000</b>，要求键入技术员密码，初始密码为 <b>0000</b>，按对应的 <b>[+]</b> 键和 <b>[-]</b> 键可更改密码数值；</p> <p>3、按下 <b>[P]</b> 键，如密码正确，即进入技术员参数设置模式，显示 <b>100-0000</b>，</p> <p>4、按下对应的 <b>[+]</b> 键和 <b>[-]</b> 键可选择参数编号并更改相应的参数值；</p> <p>5、最后按下 <b>[P]</b> 键，即退出参数设置模式，回到缝纫工作模式。</p>				
参数编号	参数范围	典型值	参数描述	备注
100	100~800	200	起缝速度	速度
101	200~5000	3500	自由缝最高速（全局最高限速）	
102	200~5000	3000	多段缝最高速	
105	100~500	250	剪线速度	
107	1~9	2	慢速起缝针数	
108	100~800	200	慢速起缝速度	
110	200~2200	1800	后固缝速度	加固缝参数
111	200~2200	1800	连续回缝速度（W 缝）	
112	200~2200	1800	前固（及 W）缝针迹补偿 1（吸合补偿，数值增大表示加快吸合）	
113	1~70	24	前固（及 W）缝针迹补偿 2（释放补偿，数值增大表示释放加快）	
114	1~70	20	后固缝针迹补偿 1（吸合补偿，数值增大表示加快吸合）	
115	1~70	24	后固缝针迹补偿 2（释放补偿，数值增大表示释放加快）	
116	1~70	20	后固缝速度	
11A	10~359	170	针迹补偿参考角度（倒缝电磁铁最佳吸合角度）	
11b	0-4	0	前后加固模式类型。（CD 与 AB 类似） 0: B→AB→ABAB→无。 1: B→无。 2: B→AB→无。 3: AB→无。 4: AB→ABAB→无。	
11C	0000-9999	0	分别对应 A/B/C/D 针数的十位，同时与前后固缝界面下所设 A/B/C/D 个位数字共同组成两位数针数，每段针数范围 1~99 针。	











11d	0000-9999	0	分别对应 E/F/G/H 针数的十位，同时与四段缝界面下所设 E/F/G/H 个位数字共同组成两位数针数，每段针数范围 1~99 针。		
130	0 / 1 / 2 / 3	2	脚踏板曲线模式： 0: 自动线性斜率（根据最高速自动计算） 1: 两段斜率； 2: 幂次曲线； 3: S 型曲线	踏板参数	
131	200~4000	3000	两段斜率：中段速度 RPM（两段斜率的转折点速度）		
132	0~1024	800	两段斜率：中段踏板模拟量（需在 138 到 139 参数之间）		
133	1 / 2	1	幂次曲线：1: 平方曲线； 2: 开方曲线；		
134	0~1024	90	踏板剪线位置		具体设置方法见图 4-1 所示。
135	0~1024	300	踏板抬压脚位置		
136	0~1024	460	踏板回中位置		
137	0~1024	480	踏板前踩运行位置		
138	0~1024	580	踏板低速运行位置（上限）		
139	0~1024	962	踏板模拟量最大值		
13A	0~800	100	踏板抬压脚确认时间		
13C	0 / 1	1	抬压脚位置抬压脚功能选择：0 不抬； 1 抬		
13E	1~800	0	剪线后抬压脚延迟时间（拨线）		
140	0 / 1	1	上电自动找上针位：0 不找； 1 找	习惯设定	
141	0 / 1	1	自动加固功能选择：（无自动加固功能的机头，最好禁止此功能）0: 禁止固缝； 1: 允许固缝		
142	0 / 1	0	手按回缝时功能模式选择 0: Juki 模式。在缝纫中途或中途停止时均有动作。 1: Brother 模式。仅在缝纫中途有动作。		
143	0 / 1 / 2 / 3	0	特殊运行模式： 0: 操作工选择（正常） 1: 简易缝模式 2: 测电机初始角（不需要取下皮带） 3: 计算传动比模式（需要有停针传感器，且不能取下皮带）		
144	0~31	0	电机低速加力功能开关： 0 正常功能； 1~31: 低速加力过厚能力档位		

148	0 / 1 / 2	0	按钮补针模式： 0:由按下时间控制；1: 补半针； 2: 补一针	
149		0	压脚下放速度减缓：缓放延迟系数，越大下放越慢	
14A	0~10	0	踏板加速速度曲线滤波系数	
150	1~100	1	计针数功能比例值设定	计数模式
151	1~9999	1	计针数上限设定值	
152	0~6	0	计针数模式选择： 0: 不计数 1: 依针数递增计数，计数满后自动重新计数 2: 依针数递减计数，计数满后自动重新计数 3: 依针数递增计数，计数满后，马达自动停止，须由复位按钮设定或面板上的 P 键来启动重新计数。 4: 依针数递减计数，计数满后，马达自动停止，须由复位按钮设定或面板上的 P 键来启动重新计数。 5: 依针数递增计数，计数满后，发出报警，剪线后马达锁住 6: 依针数递减计数，计数满后，发出报警，剪线后马达锁住	
153	1~100	1	计件数功能比例值设定	
154	1~9999	1	计件数上限设定值	
155	0~4	0	计件数模式选择： 0: 不计数 1: 计件数递增计数，计数满后自动重新计数 2: 计件数递减计数，计数满后自动重新计数 3: 计件数递增计数，计数满后，马达自动停止，须由复位按钮设定或面板上的 P 键来启动重新计数。 4: 计件数递减计数，计数满后，马达自动停止，须由复位按钮设定或面板上的 P 键来启动重新计数。	
156	0~9999	0	对应 1/2/3/4 号电磁铁斩波占空比时间选择(0 以 ms 为单位，1 以 0.1ms 为单位)	
157	0~9999	0	对应 5/6/7/8 号电磁铁斩波占空比时间选择(0 以 ms 为单位，1 以 0.1ms 为单位)	
158	0~1	0	计数可调开关（计针数和计件数）（0 可调，1 不可调）	

161	0 / 1 / 2		参数传输: 0: 无动作; 1: 下传参数; 2: 上传参数	操作类
162	1, 2		恢复出厂参数	
163	1, 2		保存当前参数为用户自定义机修参数 (可恢复)	
164			密码	
165			恢复控制器出厂参数, 并覆盖机头厂家出厂参数或用户自定义机修参数。原有参数不可恢复。	

注: 16X 参数操作保存时, 必须长时间按住  大约 3-5 秒即可保存。

### 3.2 系统员参数表

<p>1、先按住  键，后按下  键，可修改系统员参数表；</p> <p>2、液晶屏显示 <math>P d-0000</math>，要求键入系统密码，初始密码为 <math>0000</math>，按对应的  键和  键可更改密码数值；</p> <p>3、按下  键，如密码正确，即进入系统员参数设置模式，显示 <math>200-0000</math>；</p> <p>4、按下对应的  键和  键可选择参数编号并更改相应的参数值；</p> <p>5、最后按下  键，即退出参数设置模式，回到正常缝纫模式。</p>				
参数编号	参数范围	典型值	参数描述	备注
200	0 / 1 / 2	0	剪线电机运行模式选择：0：平车式；1：绷缝式（普通绷缝剪线：停到上针位后剪线）；2：包缝式：手动剪线	
202	0 / 1 / 2 / 3 / 4 / 5 / 6	1	<p>剪线时序选择：</p> <p>0： 203 号参数所设定角度[TS]处进行切线，直至上停针后延时 206 参数所设定时间[T2]为止。</p> <p>1： 203 号参数所设定角度[TS]处进行切线，直至 204 号参数所设定角度[TE]为止。</p> <p>2： 203 号参数所设定角度[TS]处进行切线，延时 206 参数所设定时间[T2]为止。</p> <p>3： 下针位信号后延迟 205 号参数所设定时间[T1]进行切线，延时 206 参数所设定时间[T2]设定时间为止。</p> <p>4： 找到上针位信号后延迟 205 号参数所设定时间[T1]进行切线，延时 206 参数所设定时间[T2]设定时间为止，大部分应用于绷缝机。</p> <p>5： 找到下针位信号后即开始进行切线动作至上停针止。然后延迟 205 号参数所设定时间[T1]后再作 206 参数所设定的切线时间[T2]。（大部分用于一般平车机型，而 T1 与 T2 设定值大部分均设为 0）</p> <p>6： 203 号参数所设定角度[TS]处进行切线东芝至上停针止。然后延迟 205 号参数所设定时间[T1]后再作 206 参数所设定的切线时间[T2]。</p>	剪线模式
203	5-359	10	剪线开始角度 TS（相对于下针位角度）	

204	10-359	120	剪线结束角度 TE (相对于下针位角度, 需大于 TS)	
205	1-999	10	剪线开始延时 T1 (ms)	
206	1-999	120	剪线结束延时 T2 (ms)	
208	10-60	20	剪线加力系数(电机加力)	
210	0 / 1 / 2 / 3 / 4 / 5 / 6	0	<p>松线电磁铁时序选择:</p> <p>0: 211 号参数所设定角度[LS]后进行松线动作, 直至上针位再延迟 214 号参数所设定时间[L2]为止。</p> <p>1: 211 号参数所设定角度[LS]后进行松线动作, 直至 212 号参数所设定角度[LE]为止。</p> <p>2: 211 号参数所设定角度[LS]后进行松线动作, 延迟 214 号参数所设定时间[L2]为止。</p> <p>3: 下针位信号后延迟[L1]设定时间进行松线动作, 延迟 214 号参数所设定时间[L2]为止。</p> <p>4: 上针位信号后延迟[L1]设定时间进行松线动作, 延迟 214 号参数所设定时间[L2]为止。</p> <p>5: 下针位信号后即开始进行松线动作至上停针止。然后延迟 213 号参数设定时间[L1]后再作 214 号参数所设定松线时间[L2]。</p> <p>6: 211 号参数所设定角度[LS]后进行松线动作, 至上停针止。然后延迟 213 号参数设定时间[L1]后再作 214 号参数所设定松线时间[L2]。</p>	松线、扫线、夹线模式
211	5-359	25	松线电磁铁启动角度 LS (相对于下针位角度)	
212	10-359	350	松线电磁铁结束角度 LE (相对于下针位角度, 需大于 LS)	
213	1-999	1	松线电磁铁启动延迟时间 L1 (ms)	
214	1~999	10	松线电磁铁上针位后延迟时间 L2 (ms)	
215	0 / 1	1	扫线功能选择: 0: 关闭; 1: 打开	
216	1~999	10	拨线 / 扫线延迟时间 ms	
217	1~9999	70	拨线 / 扫线持续时间 ms	
218	1~999	50	拨线 / 扫线复原时间 ms	
219	0 / 1	0	夹线功能选择: 0: 关闭; 1: 打开	
218	10-359	120	夹线开始角度	

216	11-359	318	夹线结束角度	
21E	11-359	160	夹线时压脚抬起后的下放角度	
220	200~360	360	剪线后停止位置 (可实现剪线回拉功能)	模式 选择
224	0/1/2/3	0	紧急停车模式: 0: 关闭紧急停车功能 1: 紧急停于任何位置 2: 紧急停于上针位 3: 紧急停于下针位	
225	0~999	0	紧急停车前继续缝纫的针数 (根据速度与针数设定不同, 实际可能大于此数量)	
226	0/1	0	紧急停车后再启动: 0: 不可再启动, 需重新上电; 1: 信号撤销后可再次开始缝纫	
231	0/1	0	自动测试模式选择: (前面两位数所表示的测试模式设置) 0: 定针数; 1: 定时间 ( $\times 100\text{ms}$ )	
232	0~1000	300	安全开关报警确认时间 ms (直驱翻台开关和绷缝剪刀保护开关均同样处理)	
233	0~1000	50	安全开关恢复确认时间 ms	
234	0/1	0	电机转向: 1: 反转; 0: 正转	
240	0~9999	1000	电机/机头传动比: X0.001 (如果自动计算过传动比, 控制器内的该参数可能与 HMI 上的不同)	
242	0~359	0	上停针位调整角度 (相对于上针位传感器的位置偏移)	
243	0~359	175	下针位机械角度	
244	0~800	200	放压脚延迟时间 (ms)	
245	0~359	9	厚料加力开始角度	
246	0~359	57	厚料加力结束角度	
247	0~2000	0	加油提醒时间 (小时。0: 关闭此功能)	
248	0~4000	0	加油报警、禁止运行时间 (小时。0: 关闭此功能)	

250	详见下行	1	1号输入功能定义	输入功能定义
251		1	1号输入有效电平 0/1	
252		0	2号输入功能定义	
253		0	2号输入有效电平 0/1	
254		0	3号输入功能定义	
255		0	3号输入有效电平 0/1	
256		0	4号输入功能定义	
257		0	4号输入有效电平 0/1	
250-256	0: 禁止; 1: 手动倒缝; 2: 安全开关; 3: 紧急停针; 4: 布边检测; 5: 剪线开关输入; 6: 压脚开关输入; 7: 补针; 8: 前后加固逆转; 9: 压脚交互量抬起; 10: 密缝; 11: 计数器复位; 13: 压脚交替量输入 1; 14: 压脚交替量输入 2; 15: 提针锁定; 16: 拼缝压脚控制输入; 17: 双针机左转输入; 18: 双针机右转输入; 19: 副张力控制输入			
260	详见下行	1	1号电磁铁输出功能定义	输出功能定义
261		3	2号电磁铁输出功能定义	
262		4	3号电磁铁输出功能定义	
263		5	4号电磁铁输出功能定义	
264		2	5号电磁铁输出功能定义	
265		6	6号电磁铁输出功能定义	
260-267	0: 输出禁止 1: 剪线; 2: 拨线; 3: 倒缝; 4: 抬压脚; 5: 松线; 6: 夹线; 7: 吸风; 8: 吹风; 9: 针冷却; 10: 压脚交互量抬起; 11: 密缝; 12: 加固逆转悬挂状态; 13: 交互量抬起状态; 14: 密缝状态; 16: 底线计数满状态; 17: 剪线短头输出; 18: 拼缝压脚输出; 19: 双针左转针杆吸合; 20: 双针右转针杆吸合; 21: 双针左转状态; 22: 双针右转状态; 23: 副张力控制输出吸合; 24: 副张力控制状态			
270	1~500	50	1号电磁铁全出力时间 ms	电磁铁组 1
271	1~100	1	1号电磁铁斩波每周期开通时间 ms(保留)	
272	1~100	1	1号电磁铁斩波每周期关闭时间 ms(保留)	
273	0~600	0	1号电磁铁保护时间 100ms	
274	1~500	70	2号电磁铁全出力时间 ms	
275	1~100	1	2号电磁铁斩波每周期开通时间 ms(保留)	
276	1~100	1	2号电磁铁斩波每周期关闭时间 ms(保留)	
277	0~600	0	2号电磁铁保护时间 100ms	

278	1~500	150	3号电磁铁全出力时间 ms	
279	1~100	1	3号电磁铁斩波每周期开通时间 ms(保留)	
27A	1~100	1	3号电磁铁斩波每周期关闭时间 ms(保留)	
27b	0~600	0	3号电磁铁保护时间 100ms	
27C	1~500	100	4号电磁铁全出力时间 ms	
27d	1~100	1	4号电磁铁斩波每周期开通时间 ms(保留)	
27E	1~100	1	4号电磁铁斩波每周期关闭时间 ms(保留)	
27F	0~600	0	4号电磁铁保护时间 100ms	
280	1~500	40	5号电磁铁全出力时间 ms	电 磁 铁 组 2
281	1~100	0	5号电磁铁斩波每周期开通时间 ms(保留)	
282	1~100	0	5号电磁铁斩波每周期关闭时间 ms(保留)	
283	0~600	0	5号电磁铁保护时间 100ms	
284	1~500	100	6号电磁铁全出力时间 ms	
285	1~100	0	6号电磁铁斩波每周期开通时间 ms(保留)	
286	1~100	0	6号电磁铁斩波每周期关闭时间 ms(保留)	
287	0~600	0	6号电磁铁保护时间 100ms	



### 3.3 监控参数表

1、先按住  键，后按下  键，可进入监控模式，液晶屏默认显示 024 号参数 **0240000**；

2、按下对应的  键和  键可选择参数编号，即可实时监视对应参数变化；

3、最后按下  键，即退回到正常缝纫模式。

010	针数计数	023	初始角度
011	计件数	024	机械角度
020	母线电压	025	踏板电压采样值
021	机头速度	026	机头传动比实际值
022	相电流	028	机头交互量电压采样值
030-037	历史故障代码	029	DSP 软件版本号

### 3.4 安全报警

报警代码	代码含义	解决措施
<b>ALA-1</b>	加油提醒	按 P 键可暂时取消报警。请及时加油
<b>ALA-2</b>	计针数报警	表示计针数已达所设上限，按 P 键可取消报警并重新计数
<b>ALA-3</b>	计件数报警	表示计件数已达所设上限，按 P 键可取消报警并重新计数
<b>ALA-4</b>	紧急停车	再按下紧急停车按钮，可消除紧急停车状态
<b>ALA-5</b>	提针锁定	再按下提针锁定按钮，可消除提针锁定状态
<b>POH0FF</b>	断电提醒	请等候 30 秒再重新打开电源开关
<b>ARN UP</b>	翻台开关报警	摆正机头，确保翻台开关复原

### 3.5 故障代码表

若系统出现报错或报警，请首先检查如下项：

1、先确认机器的连接线是否连接完好；2、确认电控和机头是否匹配；3、确认恢复出厂是否准确。

故障代码	代码含义	解决措施
Err-01	硬件过流	关闭系统电源，30 秒后重新接通电源，控制器若仍不能正常工作，请更换控制器并通知厂方。
Err-02	软件过流	
Err-03	系统欠压	断开控制器电源，检查输入电源电压是否偏低（低于 176V）。若电源电压偏低，请在电压恢复正常后重新启动控制器。若电压恢复正常后，启动控制器仍不能正常工作，请更换控制器并通知厂方。
Err-04	停机时过压	断开控制器电源，检查输入电源电压是否偏高（高于 264V）。若电源电压偏高，请在电压恢复正常后重新启动控制器。若电压恢复正常后，启动控制器仍不能正常工作，请更换控制器并通知厂方。
Err-05	运行时过压	
Err-06	电磁铁回路故障	关闭系统电源，检查电磁铁连线是否正确，是否有松动、破损等现象。若有则及时更换。确认无误后重启系统，若仍不能工作，请更换控制器并通知厂方。
Err-07	电流检测回路故障	关闭系统电源，30 秒后重新接通电源观察是否能正常工作。重试几次，若该故障频繁出现，请更换控制器并通知厂方。
Err-08	电机堵转	断开控制器电源，检查电机电源输入插头是否脱落、松动、破损，是否有异物缠绕在机头上。排除后重启系统仍不能正常工作，请更换控制器并通知厂方。
Err-09	制动回路故障	关闭系统电源，检查电源板上白色的制动电阻接头是否松动或脱落，将其插紧后重启系统。若仍不能正常工作，请更换控制器并通知厂方。
Err-10	HMI 通讯故障	检查控制面板与控制器的连线是否脱落、松动、断裂，将其恢复正常后重启系统。若仍不能正常工作，请更换控制器并通知厂方。
Err-11	机头停针信号故障	检查机头同步信号装置与控制器的连线是否松动，将其恢复正常后重启系统。若仍不能正常工作，请更换控制器并通知厂方。
Err-12	电机初始角度检测故障	请断电后再尝试 2-3 次，若仍报故障，请更换控制器并通知厂方。
Err-13	电机 HALL 故障	关闭系统电源，检查电机传感器接头是否松动或脱落，将其恢复正常后重启系统。若仍不能正常工作，请更换控制器并通知厂方。
Err-14	DSP 读写 EEPROM 故障	关闭系统电源，30 秒后重启系统，若仍不能正常工作，请更换控制器并通知厂方。
Err-15	电机超速保护	
Err-16	电机反转	
Err-17	HMI 读写 EEPROM 故障	
Err-18	电机过载	

## 4 特殊功能操作说明

### 4.1 上停针位调整

1		<p>控制系统在恢复出厂后，可根据需要重新设置上针位！</p> <p>第一步：先按住  键，再按  键，即进入监控模式，默认为 024 号监控参数，液晶屏显示当前角度，如为 0° 表明此位置为系统当前默认的上停针位置。</p>
2		<p>第二步：转动手轮，让挑线杆到上停针位置或希望调整到的合适位置，此时液晶屏显示调整后的上停针位，如 124°</p>
3		<p>第三步：先按住  键，再按  键，使机械偏转角度归零，上停针位设置完成。最后按  键退出。</p>

### 4.2 一键恢复机头厂家参数值

1		<p>如果希望恢复机头厂家的出厂参数，可按照如下步骤：</p> <p>第一步：先按住  键，再按  键，即进入监控模式，默认为 024 号监控参数。</p>
2		<p>第二步：长按  键 3 秒钟以上，开始一键恢复机头厂家参数，液晶屏显示横杠，表明正在恢复参数，此时控制器切勿断电或拔出操作面板插头。</p>
3		<p>待数码管显示全 8，表明机头厂家参数恢复完成。</p>

### 4.3 脚踏板灵敏度调整

脚踏板动作由初始位置①（136 号参数）开始，缓慢向前踩至②（137 号参数）开始低速缝纫，继续前踩至③（138 号参数）开始加速，再深踩至④（139 号参数）达到最高速度。②③段之间维持起缝速度，③④段之间为无级调速过程；

1、当脚踏板由初始位置①（136 号参数）开始，缓慢后踩至⑤（135 号参数）时抬压脚自动抬起；

2、当脚踏板由初始位置①（136 号参数）开始，缓慢后踩至⑥（134 号参数）时自动完成剪线动作。

3、各参数数值设置需保证

(134 号参数) < (135 号参数) < (136 号参数) < (137 号参数) < (138 号参数) < (139 号参数)

4、可通过监控模式下 025 号参数实时监测不同位置下的踏板采样数值作为各参数的参考值。调整对应参数，抬压脚和前踩或后踩的动作位置也随之改变。如前踩很大距离机器还没有运转，可适当减小 137 参数（不能小于回中位置参数 136），即可提高前踩的灵敏度；若机器过于灵敏，轻触踏板机器就开始运行，可适当加大 137 参数；若不容易补针，稍微前踩，速度就迅速提高造成前冲多针，可适当增大 138 参数或减小 137 参数（即增大脚踏板低速范围），也可以适当降低初始起缝速度（100）。



图 4-1 踏板动作各位置参数示意图

### 4.4 电磁铁性能调整

按典型配置，设参数 260 为 1，表明 1 号电磁铁被设置为剪线电磁铁，则 1 号电磁铁设置参数 270~273 号即为剪线电磁铁设置参数。设参数 261 为 3，表明 2 号电磁铁被设置为倒缝电磁铁，则 2 号电磁铁设置参数 274~277 号即为倒缝电磁铁设置参数。设参数 262 为 4，表明 3 号电磁铁被设置为抬压脚电磁铁，则 3 号电磁铁设置参数 278~27B 号即为抬压脚电磁铁设置参数。

- 电磁铁速度调整

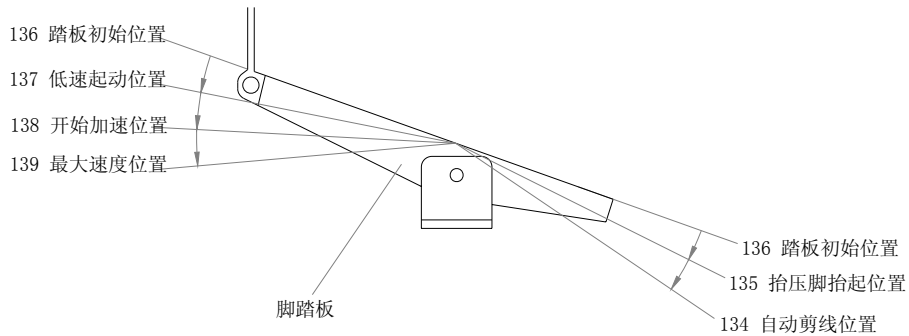

若电磁铁吸合缓慢，力度不够。可增加电磁铁全出力时间，例如增大参数 270，即增加剪线电磁铁全出力时间，从而提高剪线吸合速度、增大剪线力度。若电磁铁声音过大，可适当减小电磁铁全出力时间。

- 电磁铁容易发热

可减小占空比，适当将斩波开通时间参数（如 271 号）降低或者将关闭时间参数（如 272 号）增加（注：如果开通时间占比调整过小，可能会导致电磁铁吸合状态下力度不够甚至提前释放）。

- 电磁铁吸合无力，吸合状态的力度如何调整（怎样增大吸合时候状态的力度）可增大占空比，适当将斩波开通时间参数（如 275 号）增加，或将关闭时间参数（如 276 号）减小（注：如果开通时间占比调整过大，易使电磁铁发热）

### 4.5 前后固缝模式设置

针对固缝模式，通过前固缝按键和后固缝按键，系统默认支持①单固缝、②双固缝、③四固缝与④无固缝四种模式间切换。

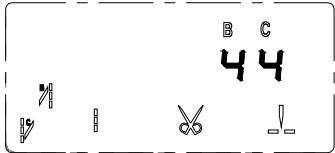
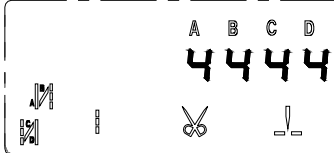
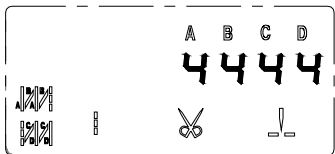
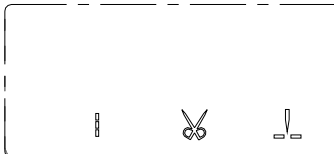
①	前单固缝、后单固缝模式 	②	前双固缝、后双固缝模式 
③	前四固缝、后四固缝模式 	④	无前、后固缝 

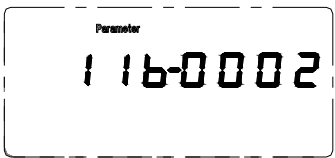
	<p>可通过调整 11B 号参数，修改固缝切换模式。若设置为 1，则只在单固缝与关闭固缝间切换；若设置为 2，则在单固缝、双固缝和关闭固缝间切换；若设置为 3，则在双固缝与关闭固缝间切换；若设置为 4，则在双固缝、四固缝和关闭固缝间切换。前固缝和后固缝模式均由 11B 号参数指定。</p>
---	---









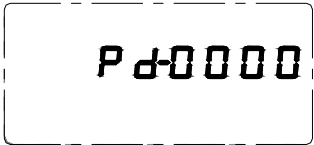

#### 4.6 前后固缝与四段缝超长针数设置



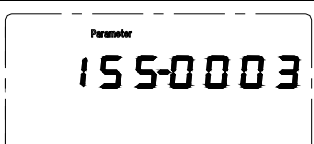

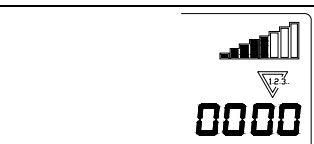
1		<p>在设置前后固缝的 A/B/C/D 段与四段缝的 E/F/G/H 段时，可选择对应的  键和  键增减设置各段数值，系统通常默认设置范围为 1~F 对应 1~15 针。</p>
2		<p>但若需要设置更多的针数，可通过修改 11C 号参数和 11D 号参数来指定欲设置针数的十位，再加上 A/B/C/D 和 E/F/G/H 段设置的个位数字，共同组成总针数。例如，在设置前后固缝针数时，默认 11C 号参数为 0000</p>
3		<p>若 A 段、C 段设置为 E，B 段、D 段设置为 4，则 A 段、C 段实际针数为 14 针，B 段、D 段实际针数为 4 针。</p>
4		<p>若任意一段的针数需设置超过 15 针，则需调整 11C 号参数。如将 11C 号参数调整为 2121，</p>
5		<p>同时相应 A/B/C/D 段分别设置为 1/6/1/6，则 A 段、C 段实际针数为 21 针，B 段、D 段实际针数为 16 针。这样，所述各段针数实际可调范围可扩展为 1~99 针。</p>
6		<p>四段缝的 E/F/G/H 各段的设置与前后固缝类似，但十位调整参数为 11D 号参数。 注：调出 11C 号参数的快捷键为同时按下  加  键；11D 号参数的快捷键为同时按下  加  键。</p>

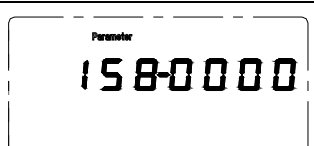
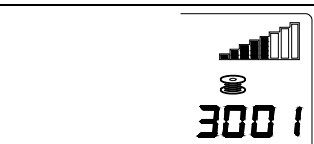
### 4.7 H-70 操作面板计针数/计件数功能

H-70 操作面板包含专门的计针数/计件数显示模块。

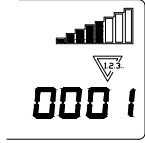
H-70 操作面板系统参数的设置方式与 H-43 面板一致。

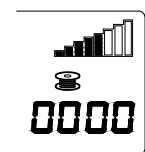
1		<p>第一步，先按住  键，再按  键，液晶屏会提示输入技术员参数密码，再按下  键进入技术员模式；</p>
2		<p>第二步，选择所需计针数模式，通常可设置为 3，即计针数满后按复位键取消报警重新计数；</p>
3		<p>第三步，再选择所需计件数模式，调到 155 号参数，亦可设置为 3，即计针数满后按复位键取消报警重新计数；然后按  键保存退出。</p>
4		<p>若开启了计针数功能或计件数功能，操作面板将对应显示计针数标识或计件数标识。当计针数功能与计件数功能均开启时，默认显示计针数值。</p>
5		<p>此时按计数切换键  可在显示计针数与计件数功能间切换。</p>
6		<p>系统通常默认开启计数设定值快捷修改的功能。可调整 158 号参数，修改为 1 则关闭此功能，默认为 0 开启此功能。</p>
7		<p>此时，显示计针数时，按计数按键区域内   键，可对计针数设定值加减；</p>

8		<p>显示计件数时，按计数按键区域内  键，可对计件数当前值加减；</p>
9		<p>按计数复位键  可对当前显示的计数值清零。</p>

386P0150

2014-4-14



## Contents

1. Installation Introduction .....	1
1.1 Product specifications .....	1
1.2 Interface connection .....	1
2 Operation Panel Instruction.....	4
2.1 Operation panel display instruction .....	4
2.2 The operation panel keys of description.....	5
3 System parameter setting .....	9
3.1 Technician mode.....	9
3.2 Administrator mode.....	14
3.3 Monitoring Mode .....	20
3.4 Safety switch warning mode .....	20
3.5 False alarm mode .....	21
4 Special function operating instructions.....	22
4.1 Upper stop position adjust.....	22
4.2 A key recovery machine manufacturers parameter value.....	23
4.3 Pedal sensitivity adjustment.....	23
4.4 Electromagnet performance adjustment .....	24
4.5 Start/ end back tacking sewing mode set .....	25
4.6 Start/ end back tacking sewing and Four-segment sewing is set long needle .....	26
4.7 H-70 operating panel count needle number / piece number function 27	

## Safety Instruction

- Please read this manual carefully, also with related manual for the machinery before use the controller.
- For installing and operating the controller properly and safely, qualified personnel are required.
- Please try to stay away from arc welding equipment, in order to avoid electromagnetic interference and malfunction of the controller.
- Keep in room below 45° and above 0°
- Do not humidity below 30% or above 95% or dew and mist of places.
- Install the control box and other components, turn off the power and unplug the power cord.
- To prevent interference or leakage accidents, please do the ground work, the power cord ground wire must be securely connected to an effective way to earth.
- All parts for the repair provided by the Company or approved before use.
- Performing any maintenance action, you must turn off the power and unplug the power cord. There are dangerous high voltage control box, you must turn the power off after one minute before opening the control box.
- This manual marked with the symbol of the Department of Safety Precautions must be aware of and strictly adhered to, so as not to cause unnecessary damage.

## 1. Installation Introduction

### 1.1 Product specifications

Product Type: AHU58A-55; AHD58A-55; Supply Voltage: AC 220 ± 20% V;

Power frequency: 50Hz/60Hz; Maximum output power: 550W;

### 1.2 Interface connection

The foot pedal and the head of each connecting plug into the socket on the corresponding controller behind, each socket name as shown in Figure 1-2. Attached, please check whether the plug is inserted.

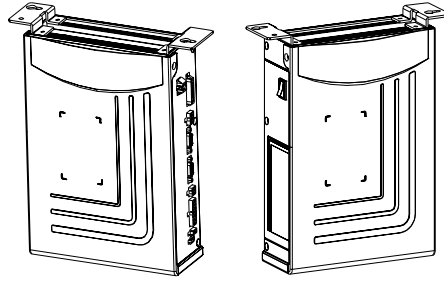

Fig.1-1 AS series Control Box

①:the motor power supply socket; ②: the pedal socket; ③:the motor encoder socket;  
 ④:the operation panel switch socket;⑤:the turn table;⑥:the automatic  
 electromagnet socket; ⑦:the presser foot lifting electromagnet socket; ⑧:the head  
 lamp socket (black); ⑨:the external synchronizer socket.

**⚠:** The use of the normal force are not inserted into the plug and socket, please check whether the matching, direction or needle insertion direction is correct! Lighting interface and presser foot lifting electromagnet interface is a 1\*2 interface, head lamp interface using black interface, please pay attention to the distinction between.

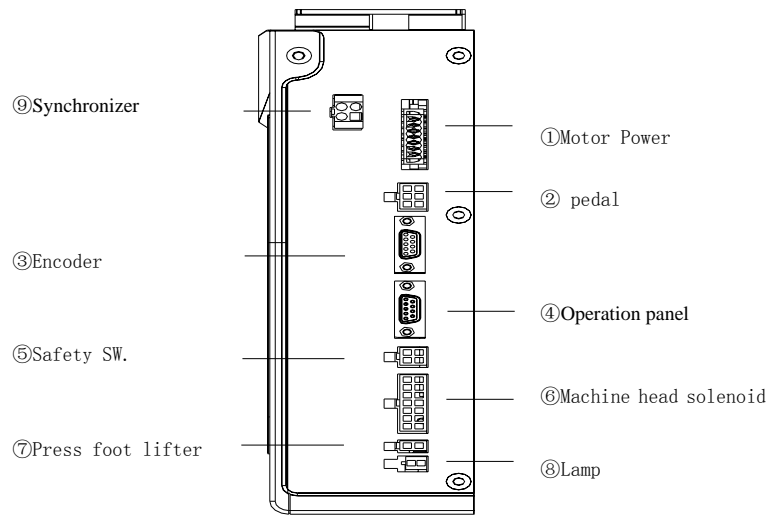

Fig.1-2 AH series control box outlet backplane

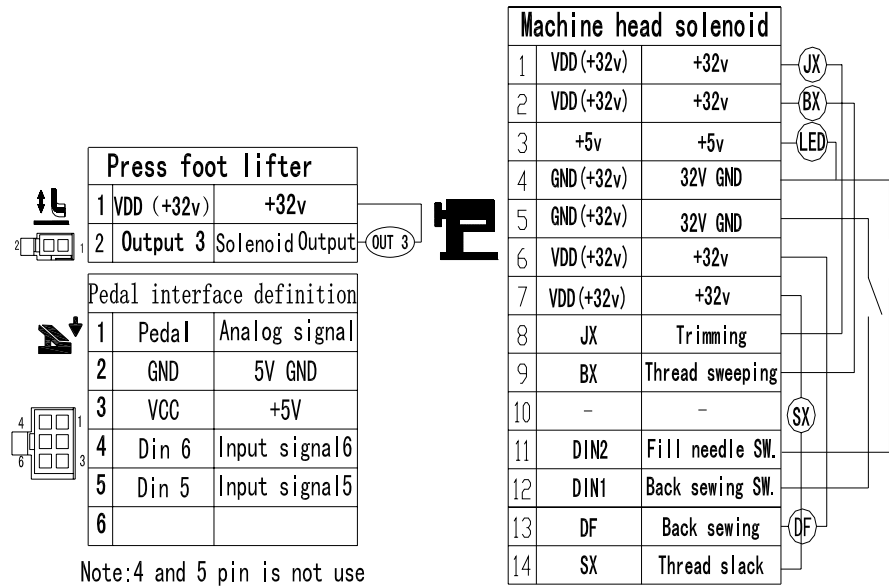



Fig.1-3 Controller interface definition

### 1.3 Power Connection and Grounding basic parameters

Please electrical engineer must do construction to the system grounding engineering. Electricity and put into use, must ensure that the power supply socket AC input has been safe and reliable grounding. System ground is yellow-green line, the line must be connected to the power grid safe reliable grounding protection, to ensure the safe use, and can prevent the abnormal situation.

: All the power line, signal line, ground wire connection not by other objects or excessive pressure to distort, in order to ensure the safe use!

## 2 Operation Panel Instruction

### 2.1 Operation panel display instruction

According to the operating condition of the system, LCD module of operation panel will display the sewing patterns, various parameters, front / back fixed seam to set the current, and the presser foot, stop needle position, trimming thread, slow up the joint character of the LCD.

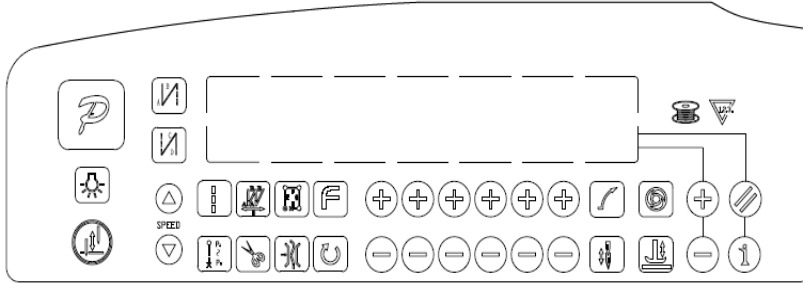

Fig.2-1 H-70 appearance

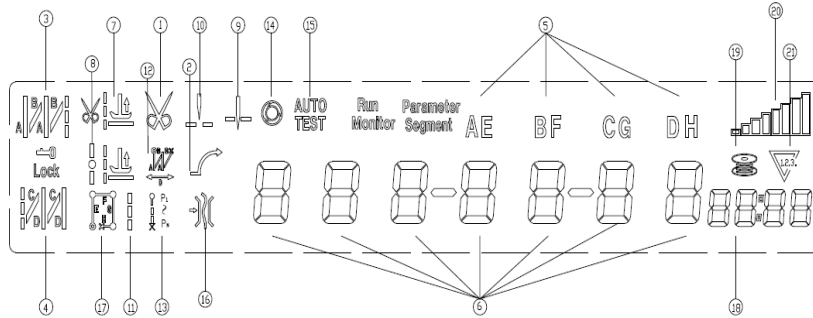

Fig.2-2 H-70 LCD screen icon

Table 2-1LCD Icon Display Description





























Index	Icon	Description	Index	Icon	Description
1		Automatic trimming	12		W sewing
2		Soft-start function	13		Multi-segment sewing
3		start back tacking	14		Multi-seam trigger function
4		End back tacking	15		Automatic test
5	AE BFCGDH	Sewing segments index	16		Clamp function















<b>6</b>		Numeric character display (pin number / parameter)	<b>17</b>		Four –segment sewing
<b>7</b>		Foot lifter after trimming	<b>18</b>		Count needle number
<b>8</b>		Middle stop foot lifter	<b>19</b>		Count piece number
<b>9</b>		Intermediate stops down stop position	<b>20</b>		Count display
<b>10</b>		Intermediate stops up stop position	<b>21</b>		Speed mark
<b>11</b>		needle and piece number of base line			

## 2.2 The operation panel keys of description









Table 2-2 Each key function introduction

No	Appearance	Name	Description
1		<b>Function key</b>	The key is parameters confirm key, and back to the previous menu until the operator sewing mode state. In addition, work with other key to set a higher level of the parameter.
2		<b>Start back tacking key</b>	It is called start back tacking function selection keys, every effective press the key once, system will be in accordance with the 11B parameter set none and single start back tacking  , double start back tacking  , four start back tacking  , LCD icon is lit at the same time. Show  is start back tacking interface, Select the corresponding  key and the  key can set needle(C、D) default range 1~F corresponds to the 1~15 pin.

No	Appearance	Name	Description
3		<b>End back tacking key</b>	<p>It is called end back tacking function selection keys, every effective press the key once, system will be in accordance with the 11B parameter set none and single end back tacking , double end back tacking , four end back tacking , LCD icon is lit at the same time. Show  is end back tacking interface, Select the corresponding  key and the  key can set needle(C, D) default range 1~F corresponds to the 1~15 pin.</p>
4		<b>Free sewing mode key</b>	<p>Press this key, the system into free sewing mode. LCD icon  is lit, step on the pedal to start sewing.</p>
5		<b>W sewing mode key</b>	<p>Press this key, system into w sewing mode, LCD icon  is lit, shown  is w sewing interface, Select the corresponding  key and the  key can set needle(A, B, D) default range 1~F corresponds to the 1~15 pin.</p>
6		<b>Multi-segment sewing mode key</b>	<p>It is called constant sewing, you press the key, the system enters to the multi segment sewing mode, LCD icon  is lit, shown  is multi-segment sewing interface,  is total segment, use  key and the  key to adjusting, the default maximum 24 segments,  is the current setting section,  as the sewing needle number of the current section, they are used  key and the  key to adjusting.</p>
7		<b>Four-segment sewing mode key</b>	<p>Press this key, system into the four segment sewing mode, LCD icon  is lit, shown  is four-segment sewing interface, Select the corresponding  key and the  key can set needle( E, F, G, H) default range 1~F corresponds to the 1~15 pin.</p>











No	Appearance	Name	Description
8		<b>Soft start key</b>	Press this key, LCD icon  is lit, show soft start function effectively, then press the icon is off, indicates close soft start function.
9		<b>Clamp string key</b>	Press this key, LCD icon  is lit, show clamp function effectively, then press the icon is off, indicates close clamp function.
10		<b>Stop position key</b>	When sewing midway stop, system upper / lower needle stop position by pressing the key,  is lit, that is up needle stop position, then press the key,  is lit, show down needle stop. the sewing complete trimming, the system will stop up needle position. Note: the H-43 panel without the key, the key  +  combination to achieve the function.
11		<b>Stitch compensation key</b>	In the free sewing midway stop or multi segment sewing section stop, press the key can realize stitch compensate function. One shot the button to fill half needle, press a long time to fill a needle, keep the continuous stitch compensate.
12		<b>Trimming key</b>	Press this key, LCD icon  is lit, indicate that the automatic trimming function effectively, then press the icon is off, indicates close trimming function.
13		<b>Press foot lifting key</b>	Each press once, system presser foot model will not automatically presser foot, trimming back automatic presser foot  , sewing to automatic presser foot  , sewing end and stop press foot lifting four modes, corresponding LCD icon is lit up at the same time

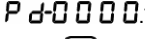

No	Appearance	Name	Description
14		<b>One-Shot-Sewing key</b>	In the multi segment sewing mode, press the key, LCD icon is lit  , suggesting that trigger mode effectively, the pedal can be accomplished once the current period of setting needle sewing; then click the icon out, show that multi segment joint triggered off.
15		<b>Lamp</b>	H-43 and H-70 panel support machine headlight dimming function, in order to press the key, can get close and from dark to bright four stage light modulation effect.
16		<b>Custom functions key</b>	Custom extension function keys, and according to the situation can work with other key combination function
17		<b>Speed increase and decrease key</b>	The highest speed of system can be fast adjustment. In the multi segment sewing mode, also as the total segments of the adjust button. In addition, the parameter setting, can be used as keys corresponding to the adjustment parameter.
18		<b>Parametric increase and decrease key</b>	Adjust the parameter values increase and decrease
19		<b>Switch key</b>	Fast switching operation, the retention, not being used (H-43 panel without this key).
20		<b>Counting switch key</b>	Counting switch meter needle number model and the piece number model (H-43 panel without this key).
21		<b>Count zero clearing key</b>	Count needle mode and piece mode current count the clear button (H-43 panel without this key).

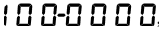
### 3 System parameter setting

#### 3.1 Technician mode

- 1、 Press  key and  key can modify the technician parameter table.
- 2、 The LCD will display .Type the password for the technician, the initial password is 0 0 0 0, press the corresponding  key and the  key can change the password value;
- 3、 Press  key, If the password is correct, enter into the technician parameter setting mode,shown .
- 4、 Press the corresponding to  key and the  key, select the parameter and change the corresponding parameter.
- 5、 Press  key, exit parameter setting mode, return to sewing mode.

NO.	Range	Default	Description	Comment
100	100-800	200	Start sewing speed	Speed
101	200-5000	3500	Maximum sewing speed	
102	200-5000	3000	Maximum constant sewing speed	
105	100-500	250	Trimming speed	
107	1-9	2	Soft start stitch number	
108	100-800	200	Soft start speed	
110	200-2200	1800	Start back tacking speed	Back tacking Para.
111	200-2200	1800	End back tacking speed	
112	200-2200	1800	W-type sewing speed	
113	1-70	24	Start back tacking, No.1 stitch compensation profile	
114	1-70	20	Start back tacking, No.2 stitch compensation profile	
115	1-70	24	End back tacking, No.1 stitch compensation profile	
116	1-70	20	End back tacking, No.2 stitch compensation profile	
118	10-359	170	Stitch compensation reference angle(optimum actuation angle of backstitch electromagnet)	

11b	0-4	0	Start and end back tacking type (CD and AB) 0: B->AB->ABAB->none 1: B->none 2: B->AB->none 3: AB->none 4: AB->ABAB->none		
11c	0000-9999	0	Corresponding to A/B/C/D pins of ten bit, start and end back tacking interface under the A/B/C/D digits together constitute the two digit pin number, each section of pin number 1~99 needle.		
11d	0000-9999	0	Corresponding to E/F/G/H pins of ten bit, start and end back tacking interface under the E/F/G/H digits together constitute the two digit pin number, each section of pin number 1~99 needle.		
130	0 / 1 / 2 / 3	2	Pedal speed-control profile mode: 0: Auto linear ramp (auto calculation according to max. speed) 1: Two segment liner Curve. 2: Power law curve 3: S-type curve	Pedal Para.	
131	200-4000	3000	Sub-Para. Of two-stage speed control: mid-turning-point speed RPM (two-stage ramp turning point speed)		
132	0-1024	800	Sub-para. Of two-stage speed control ramp: Pedal analog value of mid-turning-point (in 138 to 139 parameters)		
133	1 / 2	1	Sub-para. Of power speed control curve: 1: Square 2: Radiation		
134	0-1024	90	Trimming pedal-position		Figure 4-1 shows the specific setting method.
135	0-1024	300	Foot lifting pedal-position		
136	0-1024	460	Pedal back to Mid position		
137	0-1024	480	Pedal start running position		
138	0-1024	580	Pedal low speed running position		
139	0-1024	962	Pedal max. Analog value		
13A	0-800	100	Pedal foot lifting confirming time		

13C	0 / 1	1	Foot lifting position, foot lifting function selection: 0: without 1:with	
13E	1~800	0	Trimming after, foot lifting delay time (clamp)	
140	0 / 1	1	Run to up needle position after Power on : 0: no action 1: action	
141	0 / 1	1	Automatically reinforcing functions chose : (the machine head is not automatically reinforcing functions, the best way is prohibit) 0: prohibit 1: allow	
142	0 / 1	0	Function mode selection when manually push back tacking 0: Juki mode. During sewing or stop sewing both have this action. 1: Brother mode. Only acts during sewing.	
143	0 / 1 / 2 / 3	0	Special operation mode: 0: Operator selection 1: Simply sewing mode 2: Motor initial angle measurement (not necessary to remove the belt) 3: Ratio mode calculation (synchronize encoder is necessary and belt can not be removed)	Customize Set up
144	0~31	0	Motor torque increase function in low speed on & off: 0: Normal functions 1-31: low speed torque increase level	
148	0 / 1 / 2	0	Fill needle mode: 0: the time control ; 1: fill half needle ; 2: fill a needle	
149		0	The presser foot lowering speed slowed down: slow release delay coefficient, bigger down more slowly	
14A	0~10	0	Pedal acceleration curve filtering coefficient	
150	1~100	1	Stitch counting proportion set up	
151	1~9999	1	Stitch counting value set up	

152	□~4	□	<p>Stitch counting mode selection: 0: no counting</p> <p>1: Counting up according to stitch number, after reaching set value then restart.</p> <p>2: Counting down according to stitch number, after reaching set value then restart.</p> <p>3: Counting up according to stitch number, after reaching set value ,motor automatically stop, by the reset button set or the P key on the panel to start counting again.</p> <p>4: Counting down according to stitch number, after reaching set value ,motor automatically stop, by the reset button set or the P key on the panel to start counting again.</p> <p>5: Counting up according to stitch number, after reaching set value ,alarm, motor lock after trimming thread.</p> <p>6: Counting down according to stitch number, after reaching set value ,alarm, motor lock after trimming thread.</p>	Count Mode
153	1~100		Cunting piece proportion set up	
154	1~9999		Counting piece value set up	
155	□~4	□	<p>Trimming counting mode selection:</p> <p>0: no counting</p> <p>1: Counting up according to piece number, after reaching set value then restart.</p> <p>2: Counting down according to piece number, after reaching set value then restart.</p> <p>3: Counting up according to piece number, after reaching set value, motor automatically stop, by the reset button set or the P key on the panel to start counting again.</p> <p>4: Counting down according to stitch number, after reaching set value, motor automatically stop, by the reset button set or the P key on the panel to start counting again.</p>	

156	0~9999	0	Corresponding to 1/2/3/4, an electromagnet chopper duty time selection (0 in MS, 1 in 0.1ms)	
157	0~9999	0	Corresponding to 5/6/7/8, an electromagnet chopper duty time selection (0 in MS, 1 in 0.1ms)	
158	0~1	0	Counting adjustable switch (gauge needle number and piece number (0) adjustable, 1 non adjustable)	
161	0 / 1 / 2		Para. transmission method: 0: no action; 1: Para. Download (from operation panel to controller); 2: Para. Upload (from controller to operation panel).	Operation
162	1,2		Recover to default para.	
163	1,2		Save current para. As User custom para.(recoverable)	
164	-		Password	
165	-		Recovery controller factory parameters, and covering the head factory parameter or user defined mechanical parameters. The original parameters can not be restored.	

Note: Such "16x "parameter to operate is saved, you need press  key, about 3-5 seconds, it is saved.

### 3.2 Administrator mode

<p>1、 Press <b>P</b> key and <b>⊙</b> key can modify the administrator parameter table.</p> <p>2、 The LCD will display <b>P d-0000</b>.Type the password for the administrator, the initial password is <b>0000</b>, press the corresponding <b>+</b> key and <b>-</b> key can change the password value;</p> <p>3、 Press <b>P</b> key, If the password is correct, enter into the administrator parameter setting mode,shown <b>200-0000</b>,</p> <p>4、 Press the corresponding to <b>+</b> key and <b>-</b> key, select the parameter and change the corresponding parameter.</p> <p>5、 Press <b>P</b> key, exit parameter setting mode, return to sewing mode.</p>				
NO.	Range	Default	Description	Comment
200	0 / 1 / 2	0	<p>Trimming motor operation mode selection:</p> <p>0: flat sewing machine</p> <p>1: interlock machines ( ordinary flat seaming shearing line: stop to the needle position after the trimming )</p> <p>2: The over-lock type: manual trimming</p>	Trimming Mode
202	0 / 1 / 2 / 3 / 4 / 5 / 6	1	<p>Trimming time sequence selection:</p> <p>0: The parameter 203 set angle[TS] start trimming, until the parameter 206 upper needle stop position is reached, then time delay to [T2] set value.</p> <p>1: The parameter 203 set angles [TS] start trimming, until the parameter 204 set [TE] angle.</p> <p>2: The parameter 203 set angle [TS] start trimming, time delay to the parameter 206 set [T2] value.</p> <p>3: After lower needle stop position is reached, time delay to the parameter 205 set value [T1] then start trimming, time delay to the parameter 206 set value [T2].</p>	

			<p>4: After upper needle stop position is reached, time delay to the parameter 205 set value[T1] then start trimming, time delay to the parameter 206 set value [T2], most applications are for interlock machines.</p> <p>5: find the needle position signal started first stop pin stop tangent action. Tangent time delay [T2] and 205parameters of the set time [T1] after the 206 parameter set.(most generally used for car models, while T1 and T2 setting value most are set to 0)</p> <p>6:203 parameters that are set at [TS] of the tangent ,Toshiba first stop pin stop. Tangent time delay [T2] and205 parameters of the set time [T1] after the 206 parameter set.</p>	
203	5-359	10	Trimming start angle TS (relate to down needle stop position angle)	
204	10-359	120	Trimming finish angle TE (relate to down needle stop position angle, the value should be bigger than TS)	
205	1-999	10	Trimming start time delay T1 (ms)	
206	1-999	120	Trimming finish time delay T2 (ms)	
20A	10-60	20	trimming force coefficient (motor force)	
210	0 / 1 / 2 / 3 / 4 / 5 / 6	0	<p>Thread slack electromagnet sequential selection:</p> <p>0:211 parameter set point of [LS] after loose line, untilthe needle position to delay 214 parameter set time [L2].</p> <p>1:211 parameter set point of [LS] after loose line, until the 212 parameter set angle [LE].</p> <p>2:211 parameter set point of [LS] after loose line, 214parameters set by the [L2] until the time delay.</p> <p>3: bit signal delay [L1] set the time to loose line, 214parameters set by the [L2] until the time delay.</p>	



			<p>4: needle position signal delay [L1] set the time to looseline, 214 parameters set by the [L2] until the time delay.</p> <p>Under 5: bit signal started loose line first stop pin stop. Then the delay parameter 213 set time [L1] after the 214parameter set loose line time [L2].</p> <p>6: 211 parameter set point of [LS] after loose line, first stop pin stop. Then the delay parameter 213 set time [L1] after the 214 parameter set loose line time [L2].</p>	
211	5-359	25	Thread slack electromagnet start angle LS (relate to down needle stop position angle)	Thread slack/ Thread sweeping/ String nipping Mode
212	10-359	350	Thread slack electromagnet finish angle LE (relate to down needle stop position, the value should bigger than LS)	
213	1-999	1	Thread slack electromagnet start time delay T1 (ms)	
214	1~999	10	Thread slack electromagnet time delay T2 (ms) after upper needle stop position is reached	
215	0 / 1	1	String sweeping function selection 0: off 1: on	
216	1~999	10	Thread wiping/Thread sweeping time delay ms	
217	1~9999	70	Thread wiping/Thread sweeping time delay ms	
218	1~999	50	Thread wiping/Thread sweeping recover time ms	
219	0 / 1	0	Thread nipping function selection 0: off 1: on	
21A	10-359	120	Thread nipping initial angle	
21b	11-359	318	Thread nipping finish angle	
21E	11-359	160	Lower angle after foot lifting when thread nipping	
220	200~360	360	Stop position after trimming(can implement pull back function after trimming)	

224	0/1/2/3	0	Emergency Stop Mode: 0: Turn off the emergency stop function 1: Emergency stop at any position 2: Emergency stop at upper needle stop position 3: Emergency stop at lower needle stop position	Stop Mode
225	0~999	0	Continue stitch No. before emergency stop (according to different set speed and stitch No., the actual value might be bigger)	
226	0/1	0	Restart after emergency stop: 0: Can not be restart, it's necessary to restart the power. 1: When the alarm is canceled, can be restarted.	
231	0/1	0	Auto test mode selection: 0: With certain stitch number    1: With certain time	
232	0~1000	300	Safety alarm confirming time ms (for flat sewing machine safety tilting switch and overlock sewing machine safety knife protection switch are same, use the same solution)	
233	0~1000	50	Safety switch recover confirm time ms	
234	0/1	0	Motor resolving direction: 1: C.C.W    0: C.W.	
240	0~9999	1000	Motor/machine ratio:0.001 (If ratio has been calculated automatically, the para. In the controller might be different with HMI)	Machine Para.
241	-	-	Retain	
242	0~359	0	Adjustment angle of upper needle stop position (relate to angle difference of upper needle stop position encoder)	
243	0~359	175	Mech. Angle of lower needle stop position	
244	0~800	200	Foot lifting release time delay (ms)	
245	0~359	9	Torque increase initial angle of over thick material	
246	0~359	57	Torque increase finish angle of over thick material	

247	□~2000	□	Oil refill time alarm (hour. 0: function deactivated)	
248	□~4000	□	Oil alarm, stop operation time (hour. 0: function deactivated)	
250	As follows	I	No.1 input definition	Input function definition
251		I	No.1 active input level 0/1	
252		□	No.2 input definition	
253		□	No.2 active input level 0/1	
254		□	No.3 input definition	
255		□	No.3 active input level 0/1	
256		□	No.4 input definition	
257		□	No.4 active input level 0/1	
250 - 256	0:Disable 1:Manual back tacking 2:Safety switch 3:Emergency stop 4:Material side detection 5:Pedal trimming input 6:Pedal foot lifting input 7:Stitch compensation 8:Front-end/rear-end back tacking reverse 9:Presser foot alternation lifting 10:Air-tight joint 11:Counter reset 12:OP input 13:Presser foot alternation input 1 14:Presser foot alternation input 2 15:Needle lifting lock 16:Edge joint presser foot control input 17: Double needle machine left input; 18: Double needle machine right input; 19: Deputy tension control input			
260	As follows	1	No. 1 electromagnet output definition	Output Definition
261		3	No. 2 electromagnet output definition	
262		4	No. 3 electromagnet output definition	
263		5	No. 4 electromagnet output definition	
264		2	No. 5 electromagnet output definition	
265		6	No. 6 electromagnet output definition	
260 - 267	0:Output disable 1:Trimming 2:Thread wiping 3:Back stitch 4:Foot lifting 5:Thread slack 6:Thread nipping 7:Air sucking 8:Air blowing 9:Needle cooling 10: Presser foot alternation lifting 11: Air-tight joint 12:Back tacking reverse hanging mode 13:Alternation lifting mode 14:Air-tight joint mode 15:OP output 16:Bottom thread counter full condition 17:Trimming short thread head output 18: Edge joint presser foot control output 19: Double needle turn left needle bar actuation ; 20: Double needle turn right needle bar actuation ; 21: Double needle turn left state 22: Double needle turn right state 23: Deputy tension control output; 24: Deputy tension control state			

270	1~500	50	No.1 electromagnet fully output time ms	No.1 Electromagnet
271	1~100	1	No.1 electromagnet chopping on time ms(Reserved)	
272	1~100	1	No.1 electromagnet chopping off time ms(Reserved)	
273	0~600	0	No.1 electromagnet protection time 100ms	
274	1~500	70	No.2 electromagnet fully output time ms	
275	1~100	1	No.2 electromagnet chopping on time ms(Reserved)	
276	1~100	1	No.2 electromagnet chopping off time ms(Reserved)	
277	0~600	0	No.2 electromagnet protection time 100ms	
278	1~500	150	No.3 electromagnet fully output time ms	
279	1~100	1	No.3 electromagnet chopping on time ms(Reserved)	
27A	1~100	1	No.3 electromagnet chopping off time ms(Reserved)	
27b	0~600	0	No.3 electromagnet protection time 100ms	
27C	1~500	100	No.4 electromagnet fully output time ms	
27d	1~100	1	No.4 electromagnet chopping on time ms(Reserved)	
27E	1~100	1	No.4 electromagnet chopping off time ms(Reserved)	
27F	0~600	0	No.4 electromagnet protection time 100ms	
280	1~500	40	No.5 electromagnet fully output time ms	No.2 Electromagnet
281	1~100	0	No.5 electromagnet chopping on time ms(Reserved)	
282	1~100	0	No.5 electromagnet chopping off time ms(Reserved)	
283	0~600	0	No.5 electromagnet protection time 100ms	
284	1~500	100	No.6 electromagnet fully output time ms	
285	1~100	0	No.6 electromagnet chopping on time ms(Reserved)	
286	1~100	0	No.6 electromagnet chopping off time ms(Reserved)	
287	0~600	0	No.6 electromagnet protection time 100ms	

### 3.3 Monitoring Mode

- 1, **P** key and **↵** key press can enter the monitor mode, LCD shown is **0240000**;
- 2, press the corresponding to **+** key and **-** key to select parameter number, can be real-time monitoring of changes in the corresponding parameters;
- 3, finally press the **P** key, is to return to the normal sewing pattern

No.	Description	No.	Description
010	Count needle number	023	Initial angle
011	Count piece number	024	Mech. Angle
020	busbar voltage	025	Pedal voltage sampling value
021	Mashine speed	026	Head drive than the actual value
022	Phase currunt	027	Motor total running time (Hour)
030-037	Fault code	029	DSP software version number

### 3.4 Safety switch warning mode

Alarm code	Code meaning	solution
<b>ALA-1</b>	Refueling remind	Press the P key can temporarily cancel alarm. Please refueling
<b>ALA-2</b>	Count needle number alarm	Count needle number has reached the limit, you can press the P key to cancel the alarm and re count
<b>ALA-3</b>	Piece number alarm	Said piece number has reached the limit, you can press the P key to cancel the alarm and re count
<b>ALA-4</b>	Emergency stop	Then press the emergency stop button, can eliminate the emergency stop status
<b>ALA-5</b>	Lift needle locking	Then press the needle lifting locking button, can eliminate the needle lifting locking state
<b>POFF</b>	Power off to remind	Please wait for 30 seconds and then re open the power switch
<b>ARN UP</b>	Turn the switch alarm	Put the head, ensure the turning switch restoration

### 3.5 False alarm mode

If the system error or warning, please first check the following items:

1, to confirm the connection machine is connected properly; 2, confirm the control and head matches; 3, confirm restore factory is accurate.

error code	meaning	solution
Err-01	hardware overflow	Turn off the system power, restart after 30 seconds, if the controller still does not work, please replace it and inform the manufacturer.
Err-02	software overflow	
Err-03	system under-voltage	Disconnect the controller power and check if the input voltage is too low (lower than 176V). If yes, please restart the controller when the normal voltage is resumed. If the controller still does not work when the voltage is at normal level, please replace the controller and inform the manufacturer.
Err-04	over-voltage when the machine is off	Disconnect the controller power and check if the input voltage is too high (higher than 264V). If yes, please restart the controller when the normal voltage is resumed. If the controller still does not work when the voltage is at normal level, please replace the controller and inform the manufacturer.
Err-05	over-voltage in operation	
Err-06	solenoid circuit failure	Turn off the system power, check if the solenoid is connected correctly and if it is loose or damaged. If yes, replace it in time. Restart the system upon making sure everything is in good order. If it still does not work, seek technical support.
Err-07	electrical current checking circuit failure	Turn off the system power, restart after 30 seconds to see if it works well. If not, try several more times. If such failure happens frequently, seek technical support.
Err-08	locked motor roller	Disconnect the controller power, check if the motor input plug is off, loose or damaged, or if there is something twined on the machine head. After checking and correction, if the system still does not work, please replace the controller and inform the manufacturer.
Err-09	brake circuit failure	Turn off the system power, check if the white brake resistance plug on the power board is loose or dropped off, fasten it and restart the system. If it still does not work, please replace the controller and inform the manufacturer.
Err-10	HMI communication failure	Check if the connecting line between control panel and controller is off, loose or broken, restore it and restart the system. If it still does not work, please replace the controller and inform the manufacturer.
Err-11	machine head needle positioning failure	Check if the connection line between machine head synchronizer and controller is loose or not, restore it and restart the system. If it still does not work, please replace the controller and inform the manufacturer.
Err-12	motor original angle checking failure	Please try 2 to 3 more times after power down, if it still does not work, please replace the controller and inform the manufacturer.
Err-13	Motor HALL failure	Turn off the system power, check if the motor sensor plug is loose or dropped off, restore it and restart the system. If it still does not work, please replace the controller and inform the manufacturer.





Err- 14	DSP Read/Write EEPROM failure	Turn off the system power, restart the system after 30 seconds, if it still does not work, please replace the controller and inform the manufacturer.
Err- 15	Motor over-speed protection	
Err- 16	Motor reversion	
Err- 17	HMI Read/Write EEPROM failure	
Err- 18	Motor overload	
Err- 19	Lack of oil alarm	Add oil to the needle rod, and set the P22 parameter at 4000, resume the working time after the last oil adding; or you can press button P to close the alarm and continue to use.

## 4 Special function operating instructions

### 4.1 Upper stop position adjust

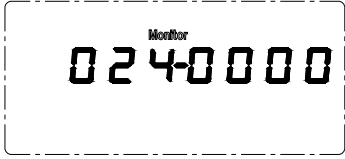
1		<p>The control system in the recovery after the factory, according to the need to re set the needle position!</p> <p>The first step: first press  key, then press  key, enter into monitor mode. The default is 024, monitoring parameters, LCD screen displays the current point of view, such as 0 ° shows that this position is the system default on the needle stop position.</p>
2		<p>The second step: turn the hand wheel, let the thread take-up lever to the needle stop position or hope appropriate position adjusting to, the liquid crystal display screen adjustment of needle position, such as 124 °</p>
3		<p>The third step: first press  key, then press  key, make the mechanical deflection angle is zero, on needle position set. Finally, according to the key to exit.</p>

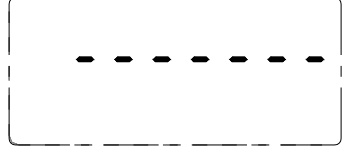
## 4.2 A key recovery machine manufacturers parameter value

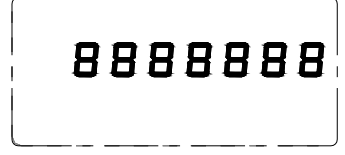
1		<p>If you want to restore the factory parameters, according to the following steps:</p> <p>The first step: first press  key, then press  key, enter into monitor mode; The default is 024, monitoring parameters.</p>
2		<p>The second step: long press  key for more than 3 seconds, start a key recovery machine factory parameters, LCD screen display bar, that is the restore parameters, the controller is not power or unplug the plug operation panel.</p>
3		<p>The digital tube display is 8 all, the nose factory parameters restore completed.</p>

## 4.3 Pedal sensitivity adjustment

Pedal movement by the initial position of the (parameter 136) began, slowly forward step to the (parameter 137) began to low-speed sewing, before continuing on to the (parameter 138) began to accelerate, and then on to the deep (parameter 139) reach maximum speed. In the period of maintenance of sewing speed, stepless speed regulation process between the segment;

- 1、 n the pedal from the initial position to the (parameter 136) began to slow, after stepping on to the (parameter 135) when the presser foot lift automatically;
- 2、 hen the pedal from the initial position to the (parameter 136) began to slow, after stepping on to  (parameter 134) automatically complete shear line.

A value of



- 3、 the parameter settings are required to ensure that  
 (parameter 134) < (parameter 135) < (parameter 136) < (parameter 137) < (parameter 138) < (parameter 139)
- 4、 an be used as the parameter's value through the pedal real-time monitoring of 025 parameters at different positions of the monitoring mode sampling numerical. Adjusting the corresponding parameters, presser foot and step on or after step action position change. As on the great distance machine is not running, may be appropriate to reduce the 137 parameters (not less than to the location parameters in 136), can improve the sensitivity of feet; if the machine is too sensitive, touch the pedal machines began to work, it may be appropriate to increase the 137 parameters; if it is not easy to fill needle, a little feet, speed quickly improve the cause forward multi needle, may be appropriate to increase or decrease the 138 parameters of 137 parameters (i.e. adding feet pedal speed range), can also be appropriate to reduce the initial seam speed (100).

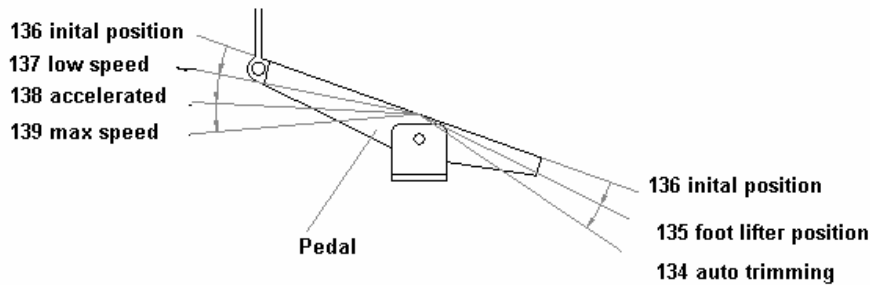

Fig. 4-1 pedal movement of each position parameter

#### 4.4 Electromagnet performance adjustment

According to the typical configuration, parameters of 260 to 1, showed that the No. 1 electromagnets are set to cut the line electromagnet, the No. 1 electromagnet set parameter 270~273 is cutting line electromagnet set parameters. Parameters of 261 to 3, showed that the No. 2 electromagnet is set to reverse stitching electromagnet,

the No. 2 electromagnet set parameter 274~277 is reverse stitching electromagnet set parameters. Parameters of 262 to 4, showed that the No. 3 electromagnets are set to the presser foot lifting electromagnet, the electromagnet is No. 3 set parameter 278~27B is the presser foot lifting electromagnet set parameters.

· electromagnetic speed adjustment

If the solenoid pull slow, inadequate. Can increase the electromagnet full output time, such as increase of parameter 270, which increases the shear line electromagnet full output time, so as to improve the shear line pull speed, increased shear line. If the electromagnet voice is too large, may be appropriate to reduce the output time.



· electromagnet easily fever

Can reduce the duty ratio, the appropriate chopper opening time parameters (such as 271) or reduce the closing time parameters (such as 272) increased (Note: if the opening time of the solenoid pull state may lead to inadequate or even ahead of the release ratio adjustment is too small,).

· the solenoid pull weakness, how to adjust the operating state dynamics (how to increase the pull strength when state

Can increase the duty ratio, the appropriate chopper opening time parameters (such as 275) increased, or the closing time parameters (such as 276) decreases (Note: if the opening time ratio adjustment is too large, easy to make the electromagnet heating)

#### 4.5 Start/ end back tacking sewing mode set

According to the fixed seam pattern, through the start back tacking sewing  key and end back tacking sewing  key, the system default support ①the single back tacking sewing , ②double back tacking sewing ③four back tacking sewing④none back tacking sewing between the four modes to switch

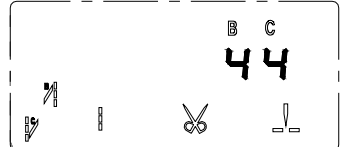
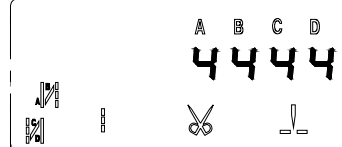
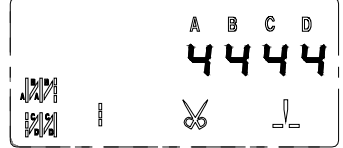
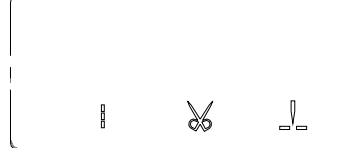
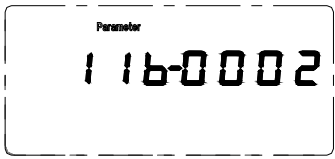
①	<p>single start/end back tacking sewing mode set</p> 	②	<p>double start/end back tacking sewing mode set</p> 
③	<p>four start/end back tacking sewing mode set</p> 	④	<p>None start/end back tacking sewing mode set</p> 
		<p>By adjusting the 11B parameters, modified back tacking sewing mode. If set to 1, only in the single fixed seam and closed seam sealing switch; if set to 2, then in the single fixed seam, double seam sealing and closing fixed seam switch; if set to 3, the double seam sealing and closing fixed seam switch; if set to 4, then in the double fixed seam, four fixed seam and close the gap between switching. Before and after the stitch seam sealing mode is specified by the 11B parameter.</p>	

#### 4.6 Start/ end back tacking sewing and Four-segment sewing is set long needle

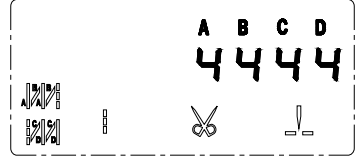





1		<p>When it is set start/end back tacking sewing of A/B/C/D and four segment sewing E/F/G/H , Select the corresponding <input type="checkbox"/> key and the <input type="checkbox"/> key can set the segment value addition and subtraction, the system default range is 1~F corresponds to the 1~15 pin.</p>
---	---	--



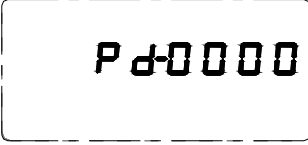



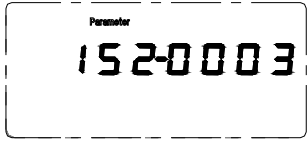
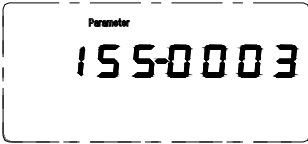



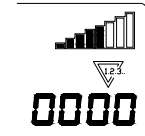

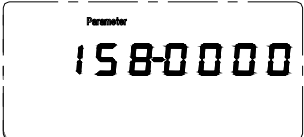
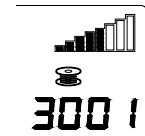
<p>2</p>		<p>But if you need to set the number of needles more, can be specified to set the number of needles by modifying 11C parameters and 11D parameters of ten, plus A/B/C/D and E/F/G/H segment is a digit, together constitute the total needle number. For example, in the setting of before and after the solid needle number, the default 11C parameters □□□□</p>
<p>3</p>		<p>If A, C segment set is E, B segment, D segment set is 4, A, C segment the actual needle is 14, B, D segment the actual needle is 4.</p>
<p>4</p>		<p>The number of needle if any segment of the need to set more than 15 needles, then adjust the 11C parameters. If the 11C parameter is adjusted to 2121</p>
<p>5</p>		<p>At the same time, the corresponding A/B/C/D segment is set to 1/6/1/6, then A segment, C segment the actual needle number 21 needle, B segment, D segment actual pin number for 16 needle. Thus, the actual number of each needle the adjustable range can be extended to 1~99 needle.</p>
<p>6</p>		<p>Set before and after the four joint E/F/G/H segments fixed seam is similar, but the ten tuning parameters for 11D parameters.                  Note: the shortcut keys out of 11C parameters for press  and  key; shortcut key 11D parameters for press  and  key.</p>

### 4.7 H-70 operating panel count needle number / piece number function

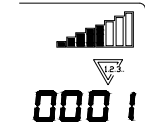
H-70 operating panel contains special count needle number / piece number display module.

H-70 operating panel system parameter is set the way and the H-43 panel is the same

1		<p>The first step, press  key, then press  key, the LCD screen will be prompted to enter the password technician parameters, then press  key to enter the technician mode;</p>
2		<p>The second step, select the desired count needle number mode, usually can be set to 3, including the number of needle after press the reset key to cancel the alarm to count;</p>
3		<p>The third step, select the required piece number mode, transferred to the 155 parameters, can be set to 3, including the number of needle after press the reset key to cancel the alarm to count; then press  key save and exit.</p>
4		<p>If the open count needle number function or piece number function, operation panel will correspond to display count needle number marking or piece number marking. When the count needle number and piece number function are open in the all, the default display count needle number.</p>

5	 	<p>At this time , press  counting key can switch count needle number and piece function in the show .</p>
6		<p>The system default settings count fast modifying function. Adjustable parameter 158, modified to 1 to disable this feature, the default is 0 open this function.</p>
7	 	<p>At this time, display the count needle number, according to the counting key area, press   keys, the count needle number of the set value addition and subtraction.</p>
8	 	<p>Display piece number, according to the counting key area, press   keys, the piece number of the current value addition and subtraction.</p>
9	 	<p>Press the reset  key of count, the count value can be cleared for the currently displayed.</p>

386P0150A

2014-4-14