

AH27 User Manual

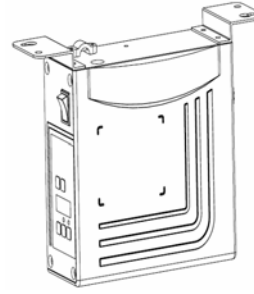

Preface





CAUTION:

Please read this manual carefully, also with related manual for the machinery before use the controller. For installing and operating the controller properly and safely, qualified personnel are required.

This product is designed for specified sewing machines and must not be used for other purposes.

If you have any problem or any comment, please feel free to contact us.

Safety Instruction

- 1) All the instruction marked with sign  must be absolutely observed or executed; otherwise, personal injuries or risk to the machine might occur.
- 2) This product should be installed and operated by persons with appropriate training only.
- 3) Before connecting power supply cords to power sources, it's necessary to make sure that the power voltage is in the range indicated on the product name plate.
- 4) Make sure to move your feet away from the pedals while power on.
- 5)  Turn off the power and remove plug prior to the following operations:
 - Connecting or disconnecting any connectors on the control box;
 - Repairing or doing any mechanical adjustment;
 - Threading needle or raising the machine arm;
 - Machine is out of work.
- 6) Make sure to fasten all the fasteners firmly in the control boxes prior to the operation of the system.
- 7) Allow an interval of at least 30 seconds before repapering the system after power off.

- 8) Repairs and maintenance work may be carried out by special trained electronic technicians.
- 9) All the replacement parts for repairing must be provided or approved by the manufacturer.
- 10) The controller must be firmly connected to a properly grounded outlet.

	CAUTION:	Be sure to connect the controller to a properly grounded outlet. If the grounding connection is not secured, you may run a high risk of receiving a serious electric shock, and the controller may operate abnormally.
---	-----------------	---

1、 Product Introduction

1.1 Overview

These Series Digital AC Servo System consist of motor and controller which are separately mounted on the same bracket, providing a very flexible mounting solution for customers. The system can execute needle-down (or needle-up) position with external-synchronizer. And it can be easily configured with different motors to match with various sewing machines, such as lockstitch, dual-needle lockstitch, heavy duty, over lock stitch, interlock stitch and direct-driven sewing machines. Employing a switch-mode power supply for the sensitive control circuitry, the system can operate over a much wider voltage range. It has the following advantages installed easy, large torque, small size, low-noise, high-efficiency, small shake and high-precision speed control. Side-mount connectors make the connection more reliable and reduce the malfunction caused by oil leakage.

1.2 Specification

Controller Type	AH27-55	AS27-70/-75	
Max. Sewing Speed (r/min)	5000	3500	3000
Voltage Range	AC (220±44)V 50/60HZ		
Output Power	550W	700W	750W
Max. Torque	3Nm	5.5Nm	6.8 Nm
Environment	0°C ~ 40°C		
The motor way of transmission	Belt drive/ Direct drive	Belt drive	

2. Installation Instructions

2.1 Motor Installation

Step 1: Mount lifting bracket. When motor installed under the machine table, as needed, to drill holes in the following diagrams (see Fig. 2-1 the example for USA base table) for the installation, mount lifting bracket.

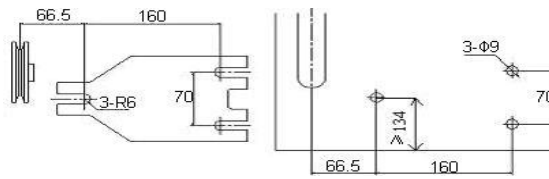

Step 2: Install the motor (see Fig.2-2) and then tighten the lifting bracket.

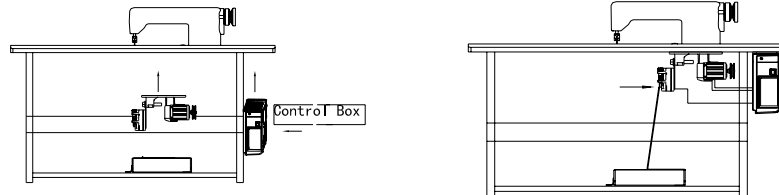

Fig.2-2

2.2 Controller Installation

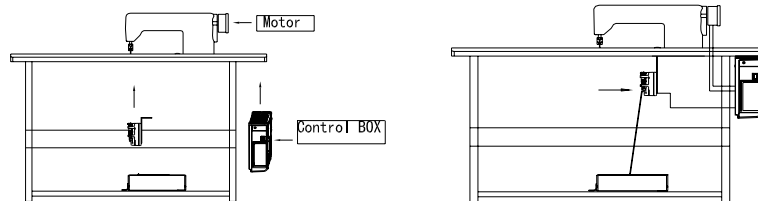

Fig.2-3

2.3 Controller shape dimension

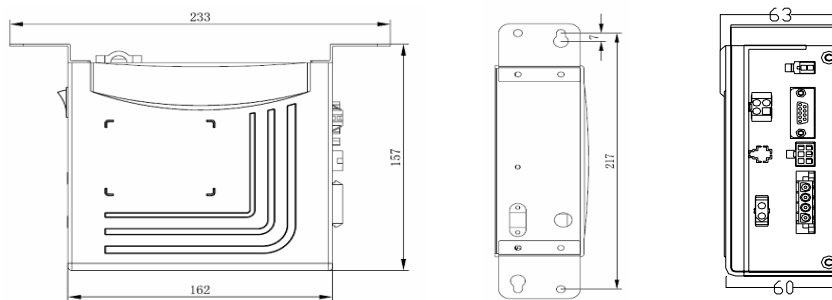

Fig.2-4

3. Power Connection and Grounding

Ground wire (Green/yellow) must be grounded. Use the correct connector and extension wire when connecting ground wire to Earth and secure it tightly (see Fig.3-1).

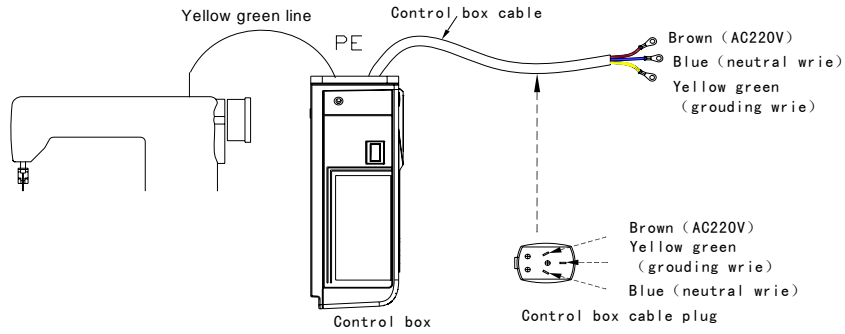

Fig. 3-1

 CAUTION	<p>Ensure all power cord, signal wire and grounding wire not be pressed by other matter or over-twisted, and not be too close to belt and belt wheel, keep 3cm-distance for safety.</p>
--------------------	---

A 1 Φ /220V power from a 3 Φ /380V Power source Connection (See Fig.3-2):

 CAUTION	<p>If the system have no Neutral point, then this servo motor is not suitable for this connection.</p>
--------------------	--

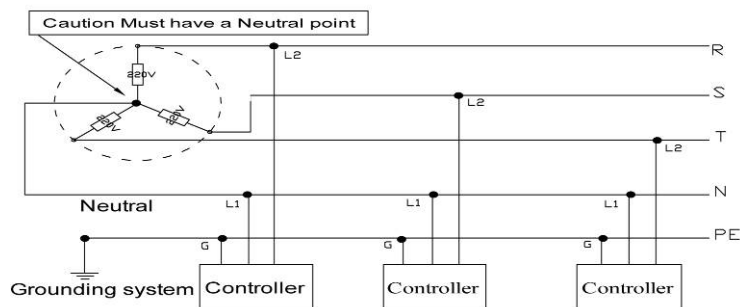

Fig. 3-2

4. Definition of controller interface

Connections between control box and other accessories are illustrated in Fig.4-1. Plug these connectors into the corresponding sockets in control box.

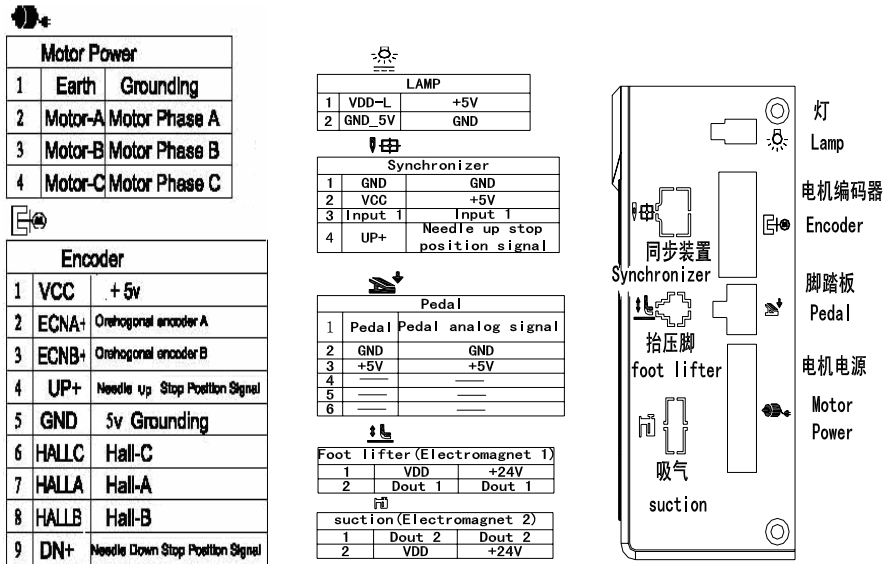

Fig. 4-1 controller link

AH27 Operation Panel (HMI) Instruction

1、Operation Panel (HMI) Instruction

1.1 Panel Instruction:

AH27 operation Panel is divided into (See Fig1-1) digital tube area and key operation area. The digital tube area is positioned in the middle of the operation panel. It consists of 3 digital tubes, used to display function setting and parameters. There are 2 keys at the top of the digital tube area, they are "P" and "S". There are 3 keys at the bottom of the digital tube area and two LED lights are located above the lower right two keys, showing the corresponding function are open or closed.

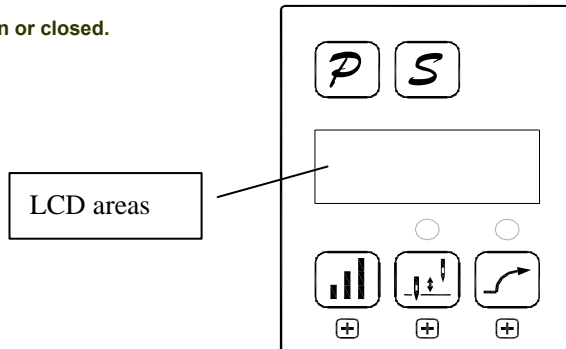







Fig.1.1 Panel Instruction

Table 1: Function of Key

No	Appearance	Description
1		Function key: Combines with other keys to set a higher level of the parameter; the password interface confirmation and other interface cancel function. "P" key pressed one time to return to the initial interaction in the parameter modification interface, not to save the current parameters.
2		Save: Confirm the operating (except the password interface), the system saves the current parameters in the parameter modification interface.
3		Hundred keys: Adjustable speed. Increase the highest bit. In the technician parameter interface, it could increase the higher bit of the parameter. Combined with the P key, it enters into the technician index interface.
4		Stop position key: Select up/down stop position. It is also used to increase the middle bit of the digital value, each effective pressing once increase a numerical.
5		Soft start key: Select soft start function. It is also used to increase the lowest bit of the digital value, each effective pressing once increase a numerical.

1.2 Digital interface instruction

Digital interface is divided with three state : The idle state, the indexing status and data display state.

1.2.1 Idle state : When power on, it is the default display state.



Fig.1.2.1 idle state

1.2.2 The indexing status has three cases:



Fig.1.2.2 technician index



Fig.1.2.3 monitor index



Fig.1.2.4 error playback index

1.2.3 Data display state :

It shows different data according to the selected index - technician parameters, control parameters and error code.





Fig.1.2.5 data display state



2、Shortcut set

In the idle state interface, it can be used to set the soft start and stop position function directly.

2.1 Soft start set

In the idle state (Fig.1.2.1), press  (5 key), the soft start function will be toggle between enable and disable. If enable the lamp above this key will be lightened () , otherwise the lamp will be off () .

2.2 Stop position

In the idle state (Fig.1.2.1), press  (4key), toggle between up and down stop position. The lamp lightened () shows that the needle will stop in the down position ,otherwise () the needle will stopped in the up position.

3、 Technical Mode

In the application, to make the controller works in a better condition or to satisfy our own demand, we can adjust the technician parameters as the following steps.

Step 1: Under idle state, first press  (1key) and hold on, then press  (3key) .Two keys are pressed at the same time, digital tube display see figure 3.1, required to enter the password. The default password is 000.



Fig.3.1 password interface





Step 2: Press  (3key),  (4key),  (5key) ,Modify the digital tube display to the correct password, and then press  (1key) . If the password is correct, enter the parameters modified index, see figure 3.2, or remain in the password input state, see figure 3.1.



Fig.3.2 technical index







Step 3: Under parameters index, press  (4key),  (5key) to modify digital tube display to the needs of the technology parameters. Technical parameters see table 1. Index number is determined, press  (2key) ,enter to parameters of interface, see figure 3.3.



Fig.3.3 technical parameters

Step 4: Press  (3key),  (4key),  (5key) to modification of digital tube display to the needs of the technology parameters.

Step 5: After parameter modified, press  (2key) , confirm the parameter modification and return to the index interface. If you don't want to save the changes by  (1 key), it will return to the idle interface. Any time can press  (1 key) is returned to the free interface.

4、R&D parameter modification

First press  (1key) and hold on, then turn the power switch, you can enter the R & D parameters; Other methods of operation with the technical parameters of operation.

5、Monitor mode

Step 1: Under idle state mode, first press  (1key) and hold on, press  (4key) .Two keys pressed at the same time, digital tube display see figure 4.1, monitor index interface.



Fig 4.1 monitor index





Step 2: Under parameters index, press  (4key),  (5key) to modification of digital tube display to the needs of monitoring index number . Monitor index see table 2. Index number is determined, press  (2key) ,enter to monitor parameters of interface, see figure 4.2.



Fig 4.2 monitor parameters

Step 3: In the monitoring parameter interface, in addition to press  (1key) of any key, returns to the monitoring parameter index interface. Press  (1key), returned to the idle state of interface.

Step 4: Repeat step 2 for other monitoring parameters or step 3 exits to monitor mode.

6、 Error playback

The controller could save the recent 8 error occurrence. Index 0 shows the most recent fault code. Index 1 stores the error code occurred before index 0's error. Fault code and fault relation, see table 3.



Step 1: In idle state , first press  (1key) and hold on, then press  (5key) ,Two keys are pressed at the same time, digital tube display see figure 5.1



Fig 5.1 error playback index





Step 2: Under error playback index, press  (4key),  (5key) to modify digital tube display to the needs of error playback index number (0-7) . Error index number display correctly, press  (2key) entered the error recording interface, view the index number of the recorded fault code, see figure 5.2.





Fig 5.2 fault code display

Step 3: In the failure code display interface, press any key except  (1key), return to error playback index interface. Press  (1key) returned to the idle state of interface.

7、 Automatic test

In the idle state interface, The first press  (1key) and  (2key) combination, then step on

the pedal controller immediately enter into the automatic test status. The controller will run according to setting about test mode and test time operation, until the end of test. Press

 (1key) and  (2key) combination again the controller will exit the test mode until the run time exhausted.

8、Transmission ratio and the initial angle test

Under idle state, press  (1key) and  (3key) combination. You can enter the technical parameter:

The initial angle test: P18 parameters adjusted to 2 (test the initial angle), the pedal is pressed to start the test, the test after the parameter back to 0 to (normal operation mode).

Transmission ratio test: P18 parameter adjustment 3 (test drive), depressing the pedal to start the test, the test after the parameter back to 0 (normal operation mode).

9、Operation note

To make the system running at peak performance, the customers for the first time using the recommended test again the initial angle and transmission ratio. R & D parameters so as not to be freely modified, and you incorrectly modify the normal use.

Table 1: Technician mode parameter:

	Index No.	Default	Rang	Comment
Speed	0	20	10~80	Minimum sewing speed (display value*10)
	1	350	20~700	Maximum sewing speed (display value*10)
	2	2	1~9	Soft start stitch number
	3	13	10~80	Soft start maximum sewing speed (display value*10)
	4	13	1~20	System accelerate sensitivity (Direct drive transmission can be set up to a large value; belt transmission don't set large value or too much noise and vibration. This parameter do not affect the electrical)
	5	20	1~80	System decelerate sensitivity (Direct drive transmission can be set up to a large value ; belt transmission don't set large value or too much noise and vibration. This parameter do not affect the electrical)

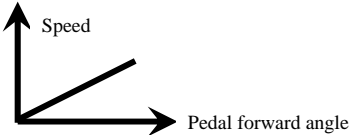
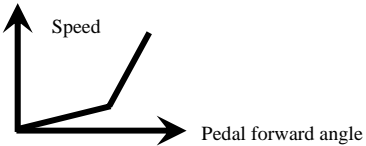
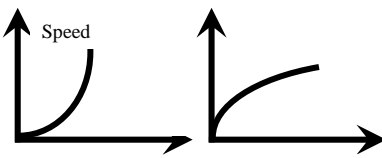
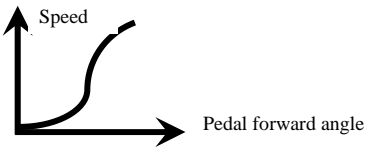
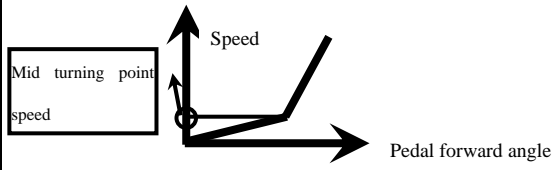
	7	6	2~200	The needle stop speed down limit .(display value * 10)
Pedal	8	2	0 / 1 / 2 / 3	<p>Pedal Curve mode setup:</p> <p>0: Auto Calculated liner Curve (According to the highest speed automatic computation)</p>  <p>1: Two segment liner Curve.</p>  <p>2: Arithmetic Curve</p>  <p>3: S curve</p> 
	9	300	20~400	<p>Two segment controls the speed slope : mid turning point speed RPM (two segment of turning point speed) , the parameter[8] set to 1 effective.</p> 

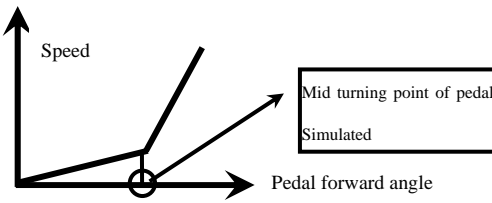
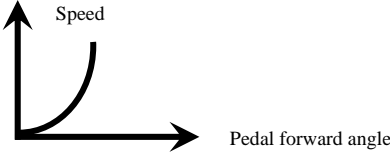
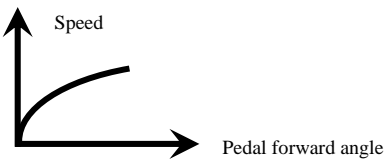
Pedal	10	800	0~999	<p>Two segment controls the speed slope : mid turning point of pedal Simulated value, the parameter[8] set to 1 effective, the value is between[15]and[16].</p> 
	11	1	1/2	<p>Arithmetic Curve supplementary parameter : the parameter[8] set to 2 effective, 1 : Square (the low speed control is very well, slow start after fast) ;</p>  <p>2 : Square root (Responding speed is fast, fast start after slow) ;</p> 
	12	190	0~999	Up stop needle position after pedal (set value shall not be higher than 【13】)
	13	460	0~999	Pedal back mid position (set value between 【12】 and 【14】)
	14	480	0~999	Pedal step upon running position (set value between 【13】 and 【15】)
	15	680	0~999	Pedal low speed running position (upper) (set value between 【14】 and 【16】)
	16	940	0~999	Pedal simulation the largest of value (set value shall not be less than 【15】)

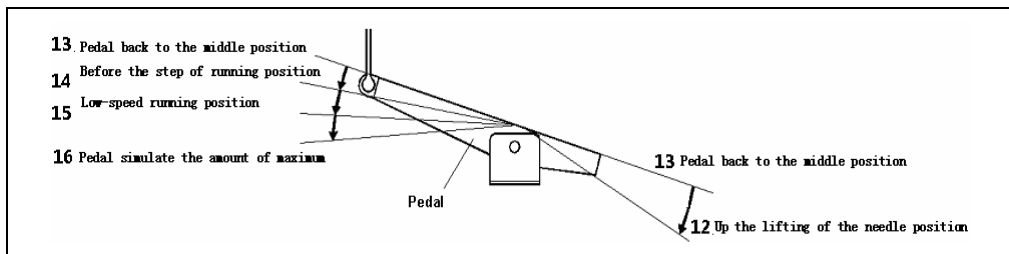

custom setup 1	17	1	0 / 1	Run to up needle position after Power on: 0: no action 1: action
	18	0	0 / 1 / 2 / 3 / 4	Special Running Mode setup: 0: free sewing mode; 1: simple sewing mode; (without stopping operation mode in the synchronous sensor fault cases using); 2: calculate initial angle of motor (do not uninstall strap); 3: calculate motor/machine head run rate mode; (synchronizer, do not uninstall strap) 4: The control system only in the current loop control running, speed open-loop.
	19	0	0~31	Torque boost up at low speed : 0: normal function 1~31: 31 levels Torque boost up
	20	1	0 / 1	Stop pin mode : 0: Constant speed tackle mode (in the belt transmission, Parking is not precision) 1: back pull mode (PMX)
	21	40	10~80	On the needle lifting speed
	22	350		Automatic test speed
	25	0	0 / 1	Electric steering: 1: reversal; 0: forward
Machine head parameter	26	100	10~500	motor/machine head run rate: 0.001 (if automatic calculation of motor/machine head run rate has done, the Parameter value in control box maybe different with that in HMI) (display value * 10)
	27	0	0~359	Up needle position mechanical angle
	28	175	0~359	Down needle position mechanical angle
	29	9	0~359	Thick material afterburner start angle

	30	57	0~359	Thick material afterburner end angle
Start/Stop mode	31	Stop position 0: up needle position ; 1: down needle position		
	32	Soft start 0: Off; 1: On.		
Automatic test	33	0	1	Automatic test mode select : 0: needle NO.; 1: time
	34	30	0~999	Automatic test total time setting (10 minute)
	35	90	1~999	Running time (0.1second) / needle NO.
	36	10	1~999	Stop time (0.1second)
Parameter saves recovery	37	0	0~11	Parameter reload(0: Lockstitch straight drive; 3: thick material; 6: 360 Lockstitch straight drive; 7: 360 lockstitch belt; 10: Nested package stretch sewing; 11: roller; 12: Double needle direct drive; 13: Overedge belt machine; 14: Nested package overedge sewing
	38	0-1		Parameter transfer : 1:read data ; 0:write data
R&D parameter	72	0	0/1	Automatic test transmission ratio
	73	280	0~999	Foot lifter position
	74	10	0~999	Pedal foot lifter confirm time (10ms)
	75	10	0~999	Pedal foot down confirm time (10ms)
	76	1	0~999	Electromagnet 1 chopping open time
	77	1	0~999	Electromagnet 1 chopping close time
	78	80	0~600	Electromagnet 1 solenoid protect time(100ms)
	79	800	0~999	Electromagnet 1 full output time
	80	1	0~3	Electromagnet 1 function 0:off; 1: foot lifter; 2:sunction: 3:+24V output
	81	1	0~999	Electromagnet 2 chopping open time
	82	1	0~999	Electromagnet 2 chopping close time
	83	80	0~600	Electromagnet 2 solenoid protect time(100ms)
	84	800	0~999	Electromagnet 2 full output time
	85	2	0~3	Electromagnet 2 function 0:off; 1: foot lifter; 2:sunction: 3:+24V output

	86	20	20~300	Plus stitch speed
	87	150	1~999	Plus half stitch delay time
	88	150	1~999	Plus a stitch delay time
	89	0	0~2	Input 1 function 0:off; 1: safe SW.; 2:plus stitch:
	90	0	0~1	Input 1 effective level

Table 2: Monitor mode parameter (show only the highest of 3 bit)

Index NO.	Comment	until
0	Bus voltage	V
1	Mechanical speed	10r/m
2	Q axis current	0.01A
3	Initial angle	degree
4	Mechanical angle	degree
5	Pedal analog sampling value	—
6	Transmission ratio	0.001
7	Version number	

Table 3: error code

error code	Error Definition	Solution
01	Hardware overload	Shut down the controller, Re-power it after 30s interval, if the controller still works abnormally, replace it and inform manufacturer.
02	Software overload	
03	Low voltage	Shut down the controller, check input power voltage, if the voltage is lower than 190V, please restart the controller after the voltage is normal, if the controller still work abnormally after the voltage is recovered to the normal level, please replace it and inform manufacturer.
04	Voltage is too high while stopping	Shut down the controller, check the input voltage is high (above 245V). If the power supply voltage is high, Restart controller after recovery, if the controller still cannot work normally please replace it and inform manufacturer.
05	Voltage is too high during Operation	
07	Current detection loop circuit fault	Shut down the controller, Re-start it 30s interval, if the controller still can not work normally replace it and inform manufacturer.
08	Motor stalled	Shut down the controller, check the motor power cord whether it is broken off,

		loosen, damaged, or be tangled on the machinery by other stuffs. Restart controller after recovery, if the controller still cannot work normally please replace it and inform manufacturer.
09	Dynamic Braking failure	Shut down the controller, check the motor power cord whether it is loosen, which is tightly inserted after restart controller, if the controller still cannot work normally please replace it and inform manufacturer.
11	Synchronizer failure	Shut down controller power, check if the connection wire between synchronizer and controller is loosened; if the controller still work abnormally after restart please replace it and inform manufacturer.
12	Initial motor angle detection failure	Restart for 2-3 times, if the controller still work abnormally, Please inform manufacturer.
13	HALL failure	Shut down the controller, check the motor power cord whether it is loosen, return normal after restart controller, if the controller still cannot work normally please replace it and inform manufacturer.
14	DSP access failure EEPROM	Shut down the controller, Re-start it 1 attempts, if the controller still work abnormally, Please inform manufacturer.
15	Motor over speed protection	Shut down the controller, Re-start it 30s interval, if the controller still work abnormally, Please inform manufacturer.
16	Irregular motor operation	Shut down the controller, Re-start it 30s interval, if the controller still work abnormally, Please inform manufacturer.
18	Motor overload	Shut down the controller, Re-start it 30s interval, if the controller still work abnormally, Please inform manufacturer.

386P0242A

2015-09-17